

Mumbai Airport



Mumbai Airport Terminal 2



Cost Per Month 33,00,000 + GST



T2 Domestic Departure Check In (L4 Entry), Unit – 6 (Double Sided), Size – 3 ft 8 in (w) * 9 ft (h) , Totem Light Box

Map View

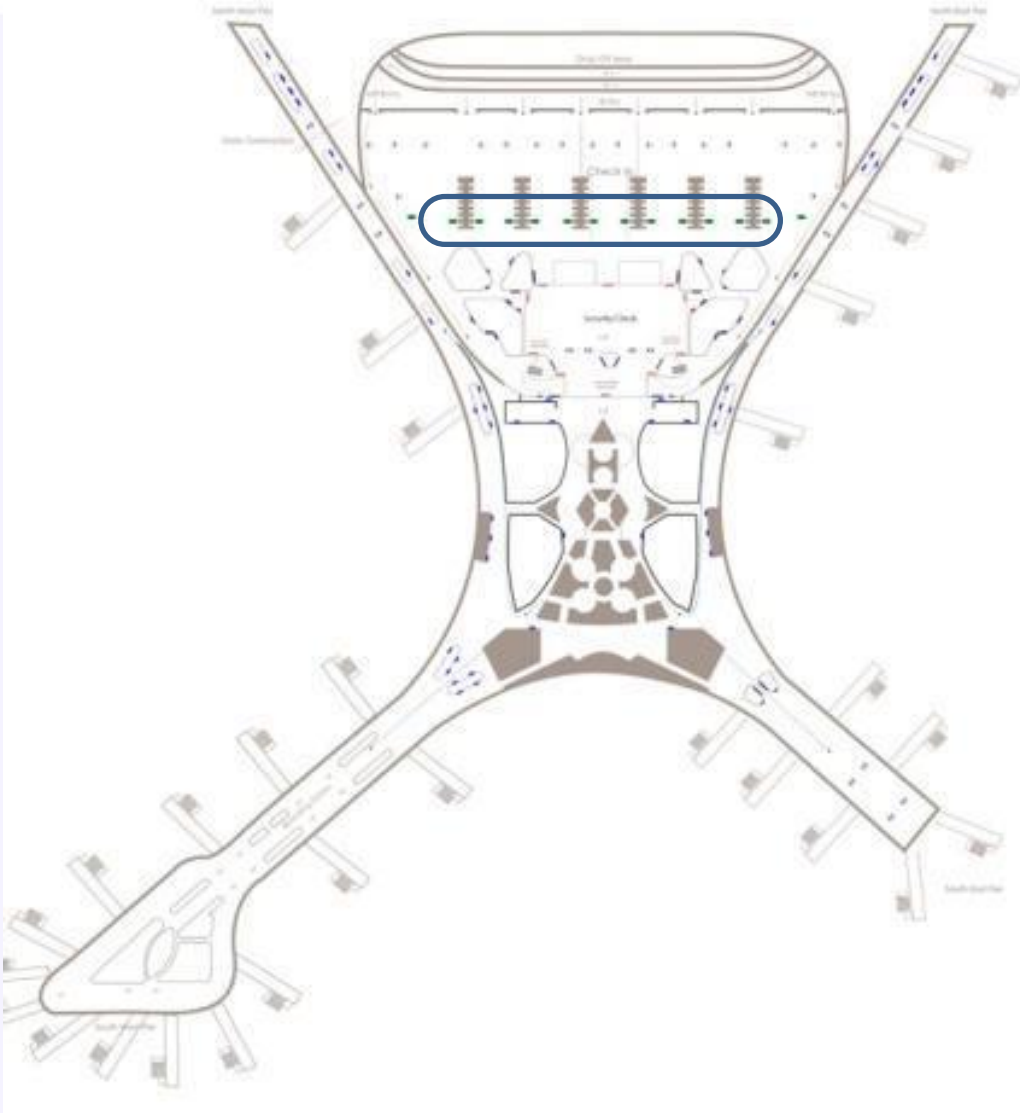

Cost Per Month 34,00,000 + GST



T2 L4, Enroute to security Check, Unit – 1, Size – 37 ft 5 in(W)X 13 ft 7 in(H), Front lit Wall wrap

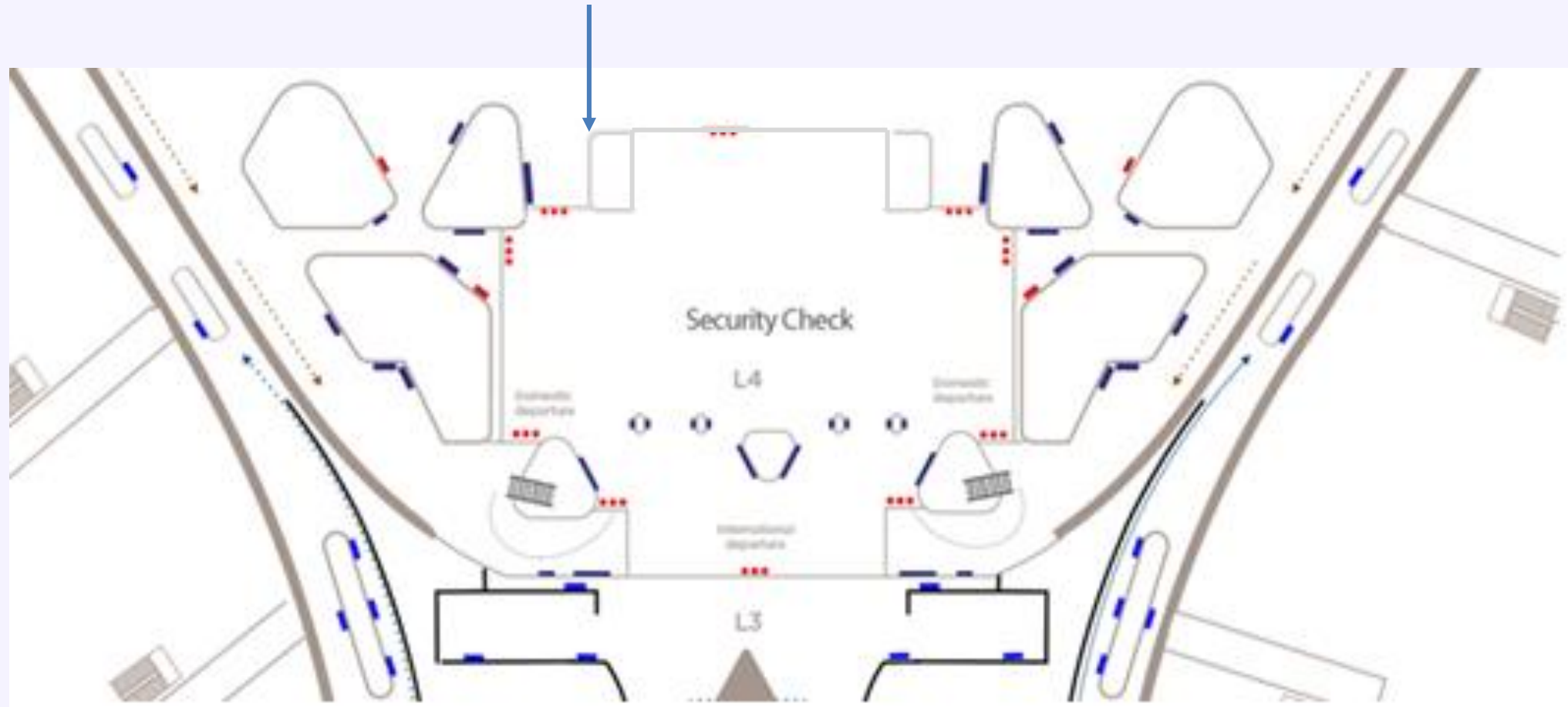

Cost Per Month 34,00,000 + GST



T2 L4, Enroute to security Check, Unit – 1, Size – 37 ft 6 in(W)X 13 ft 7 in(H), Front lit Wall wrap

Cost Per Month 33,00,000 + GST



T2 L3, Domestic SHA, Unit – 2, Size – 8 ft 5 in(W) X 7 ft 10 in(H), Video Wall

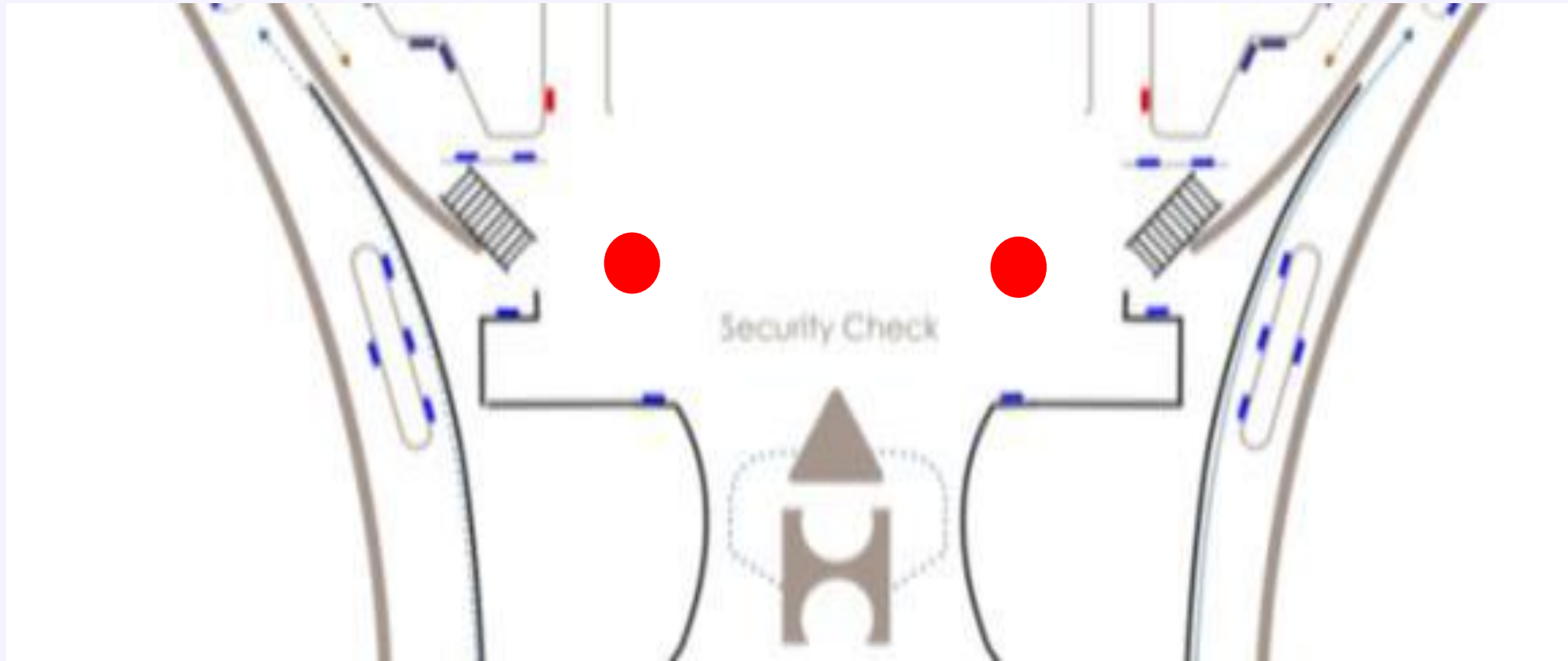

Cost Per Month 27,00,000 + GST



T2 Domestic Departure (L3 Retail Area, Bust gate at L1), Unit – 29 (Double Sided), Size – 55 inches, Digital Screens, Loop Time- 15 secs in every 3 mins

Map View

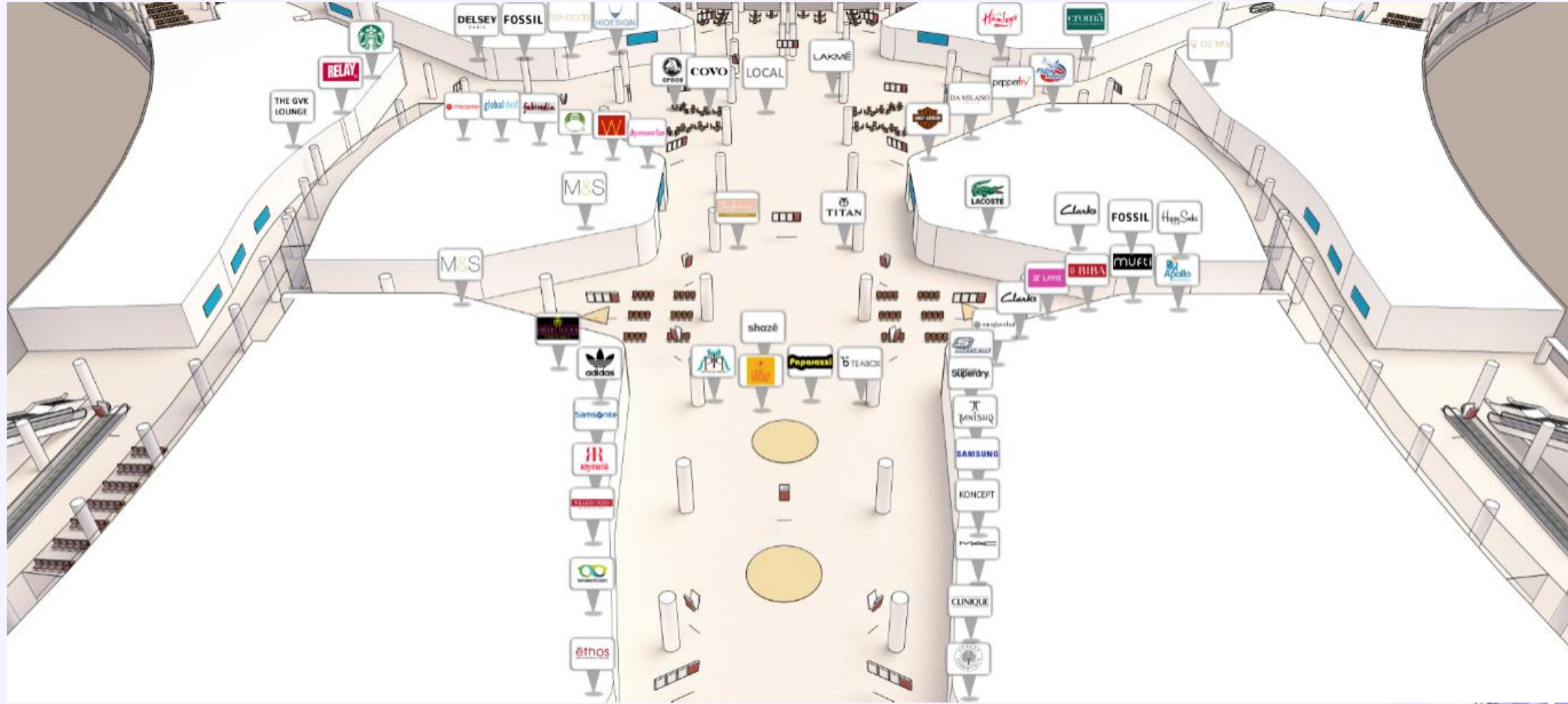

Map View

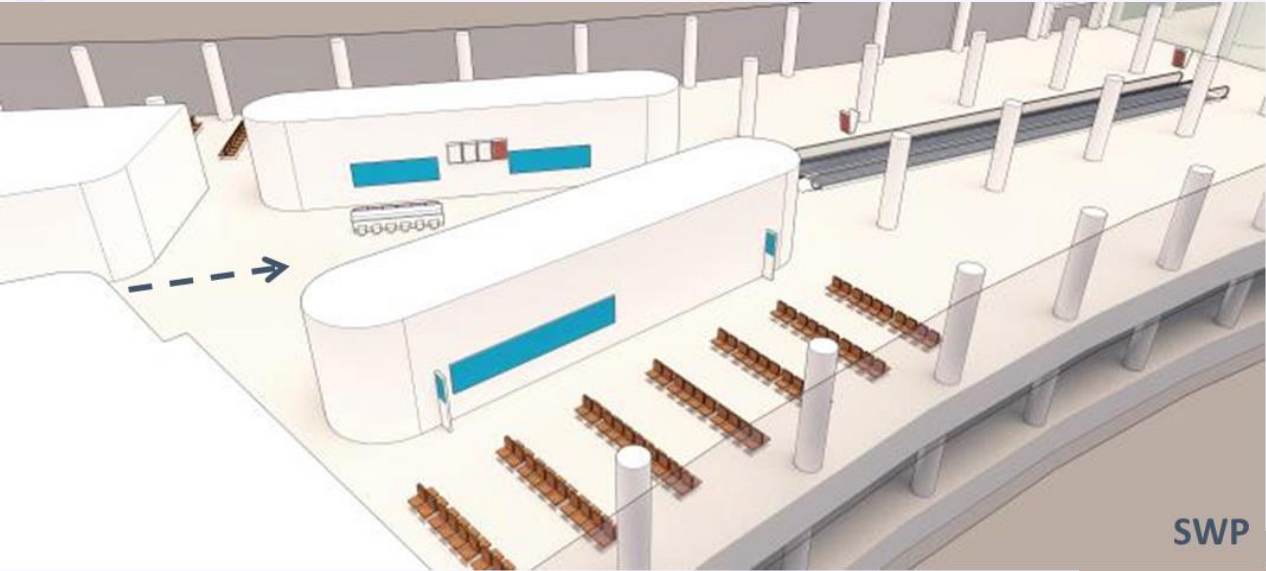

SWP



SEP

Cost Per Month 28,00,000 + GST



T2 Departure L3 SHA, Videowall at Pillar before Theobroma, Unit - 1, Size – 6 ft(W) X 8 ft(H) Video Wall, Exclusive Media

Cost Per Month 27,00,000 + GST



T2 Common Departure, L4 Entry, Post Security Check, Unit – 2, Size – 13 ft 9 in(W) X 7 ft(H), Static Backlit

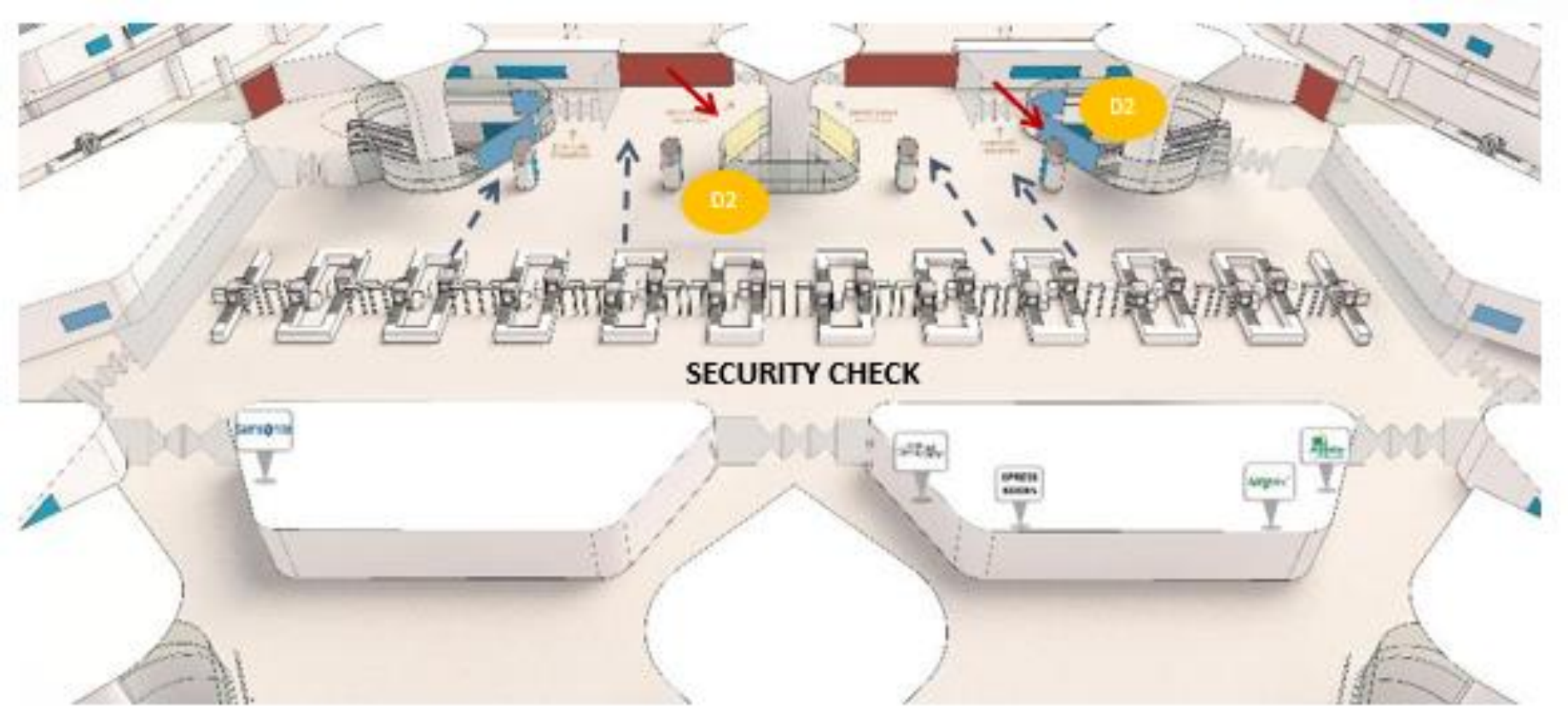

IRTH.IN

HOUSE OF TITAN

INTRODUCING IRTH BAGS



Video assistance at IRTH.IN
+91 81473 49463

SHOPPE



TIMES



Video assistance at IRTH.IN
+91 81473 49463

SHOPPE



Cost Per Month 16,00,000 + GST



T2 International Arrivals corridor, Unit - 25, Size – 65”, Loop Size – 15 Secs in every 3 mins, Digital Screen Network

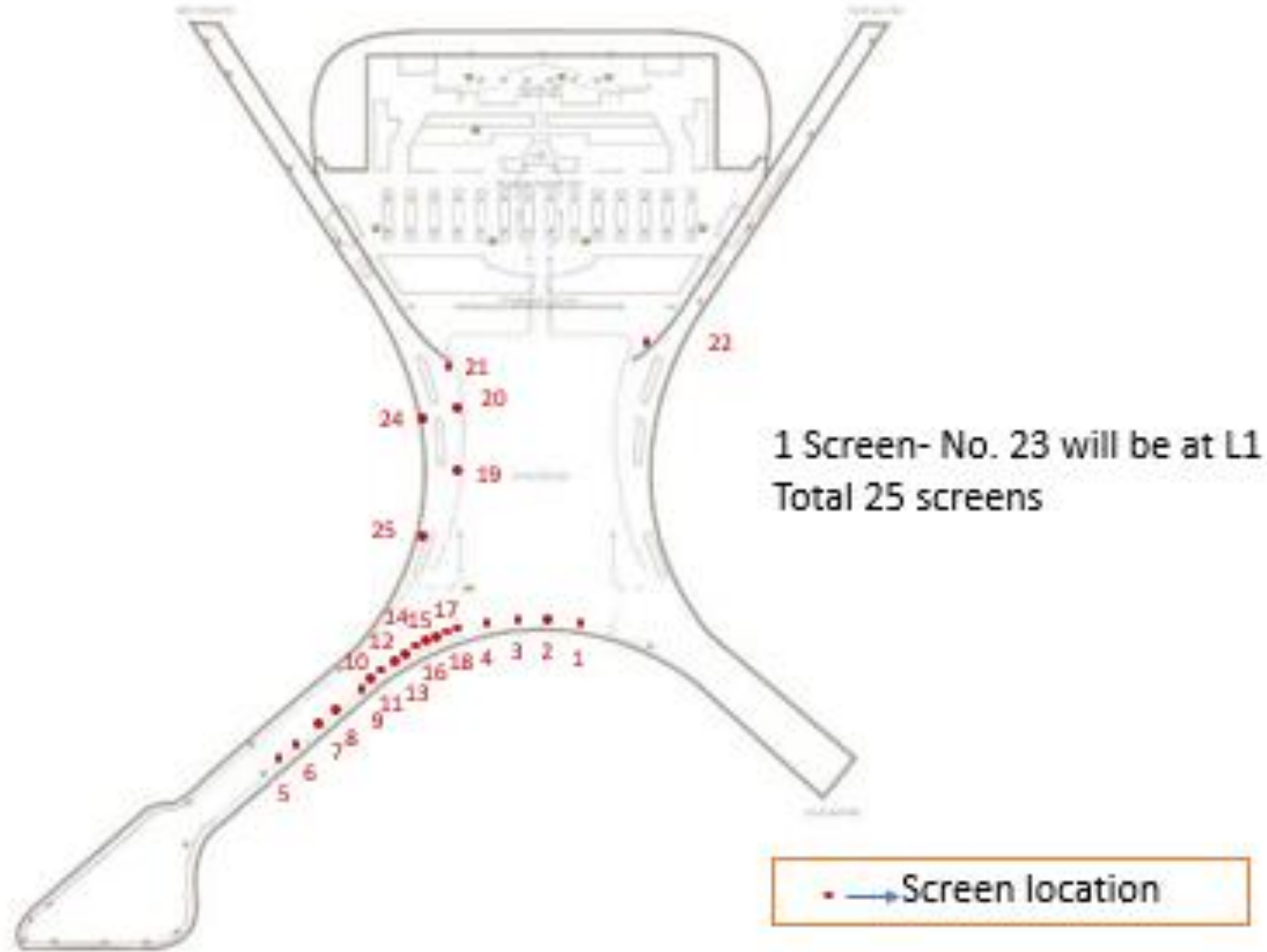

Cost Per Month 18,90,000 + GST



T2 Domestic Arrival Corridor, Unit - 38, Size – 55”, Loop Size – 15 Secs in every 3 mins, Digital Screen Network

Map View

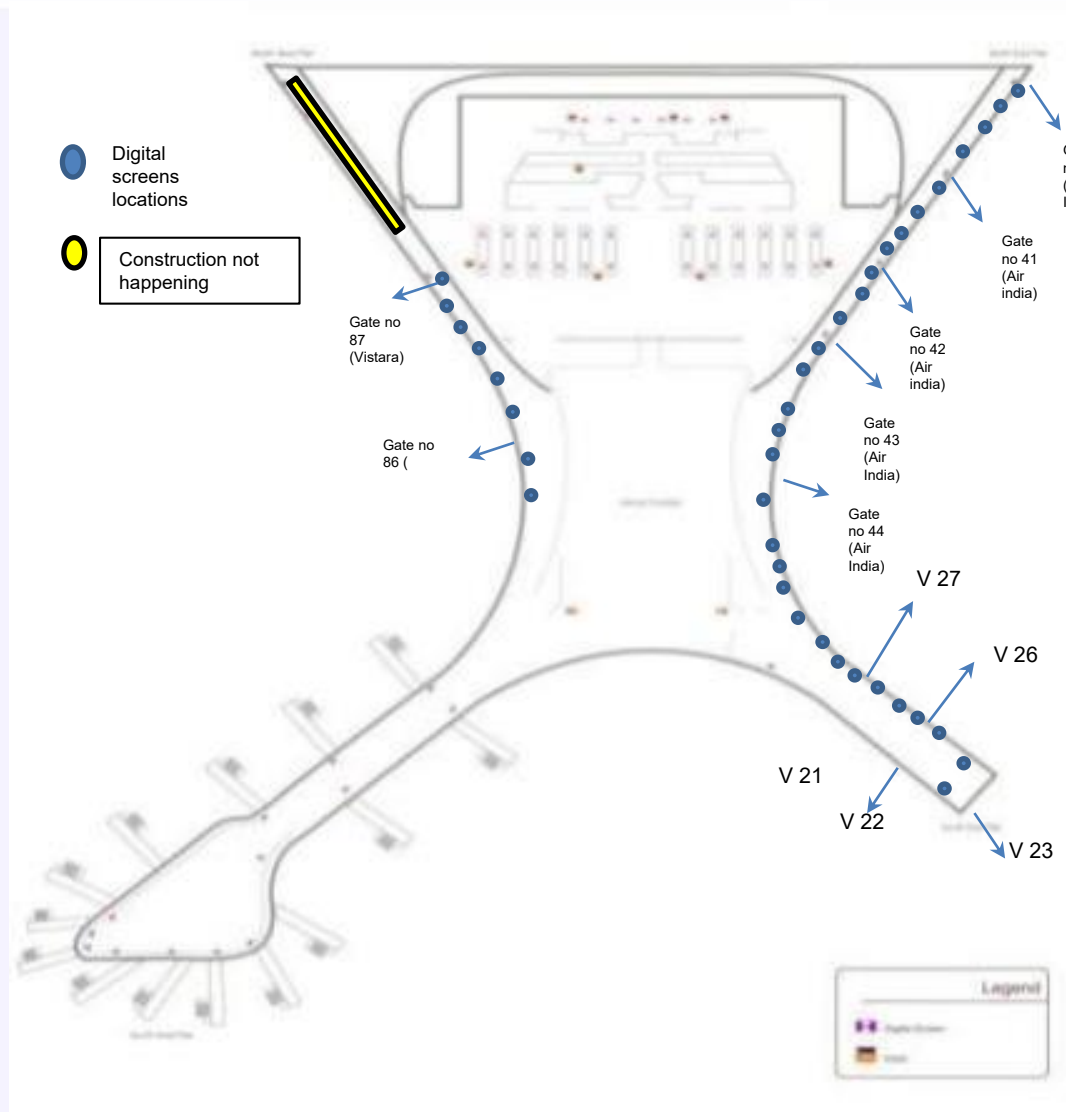



Cost Per Month 24,00,000 + GST



T2 Common Arrivals, Digital Screens, Unit 56 screens (International + Domestic), Size – 55”, LED – Loop Size – 15 Secs in every 180 secs

Map View



Cost Per Month 28,00,000 + GST



T2 Common Arrival, Digital Alley (2 Units - LHS + RHS), Unit – 2, Size – 9 ft (W) X 12 ft(H), Videowall. Loop Time- 15 secs in every 30 secs

Map View

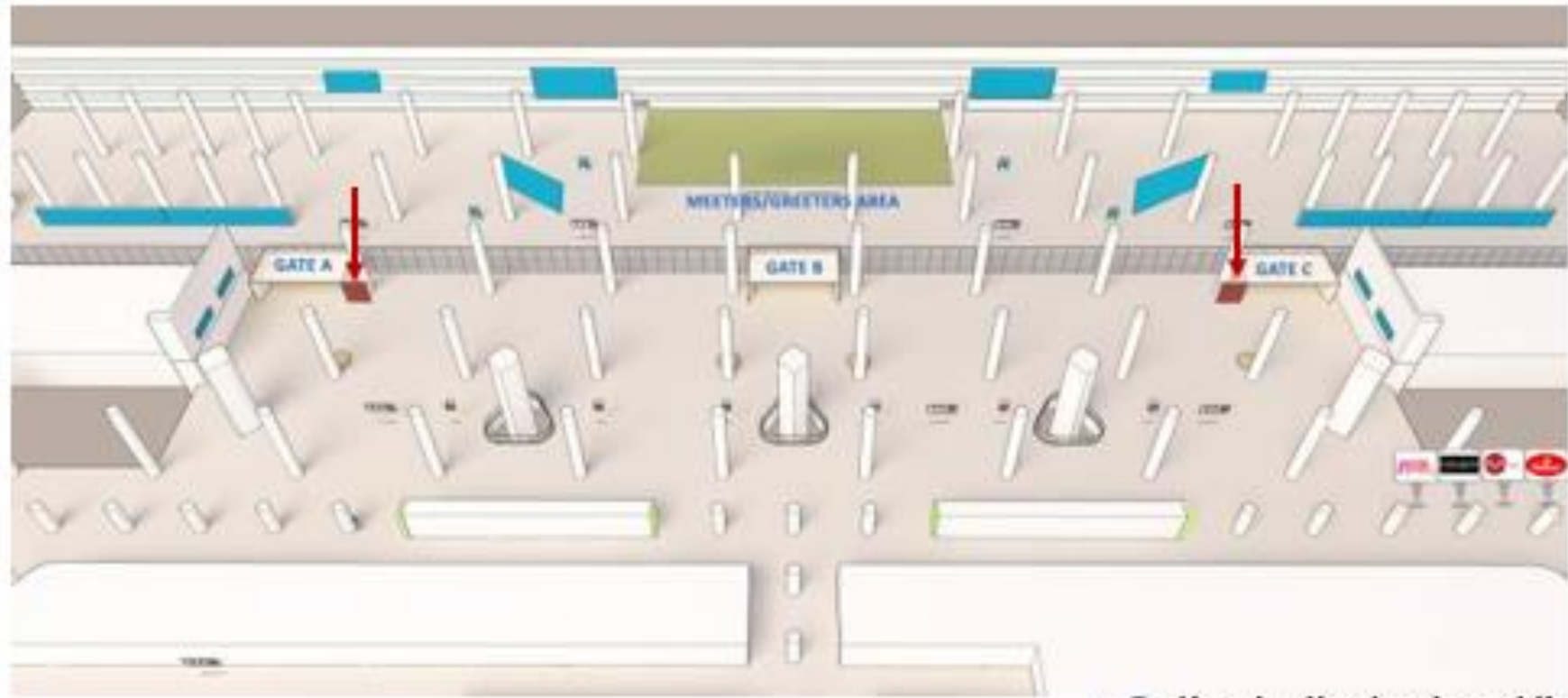

→ Denotes the direction of Passenger flow
→ Media



Round

/ Exit

Lounge

वाहनतळ / रिक्षा / बस / बाहेर जाण्याचा मार्ग
कारपार्क / रिक्षा / बस / बाहेर जाणे का मार्ग

नीचता ट्राईबीट हॉटेल आणि लारन्ज
नीचता ट्राईबीट हॉटेल और लारन्ज

प्रसाधनगृह
प्रसाधन

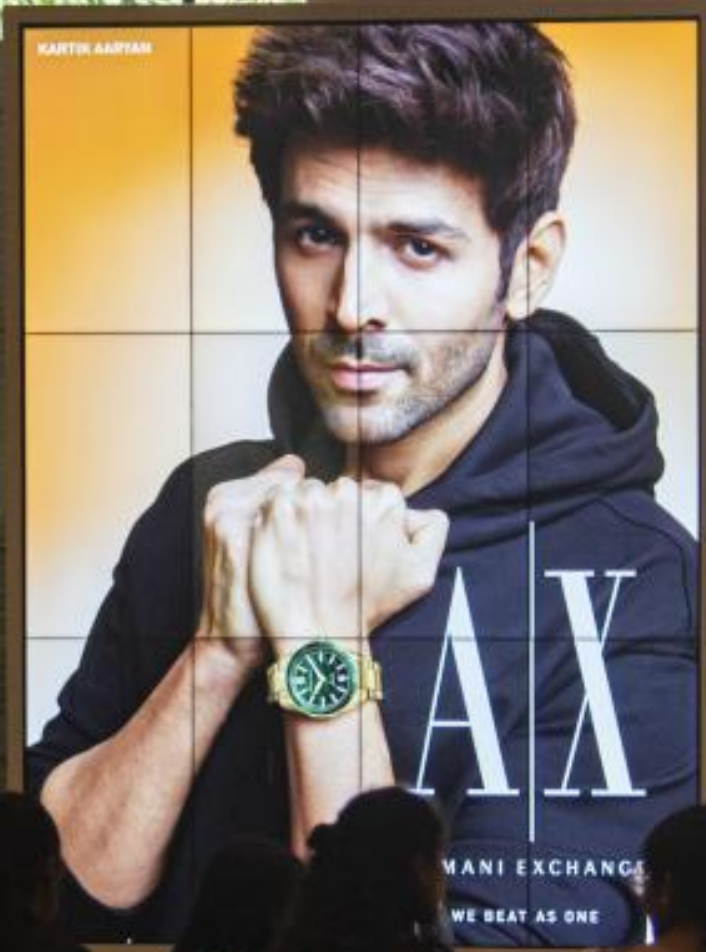

Are at Level 2,
Proceed to Level 1 for
terminal
baggage service



Mumbai Airport Terminal 1



Cost Per Month 18,00,000 + GST



T1 B Departures, Check in Hall, Outside reserve , Unit – 1 (Double Sided), Size – 10 ft 1 in (W) X 22 ft 3 in(H), 10 ft 1 in (W) X 22 ft 4 in(H), SAV

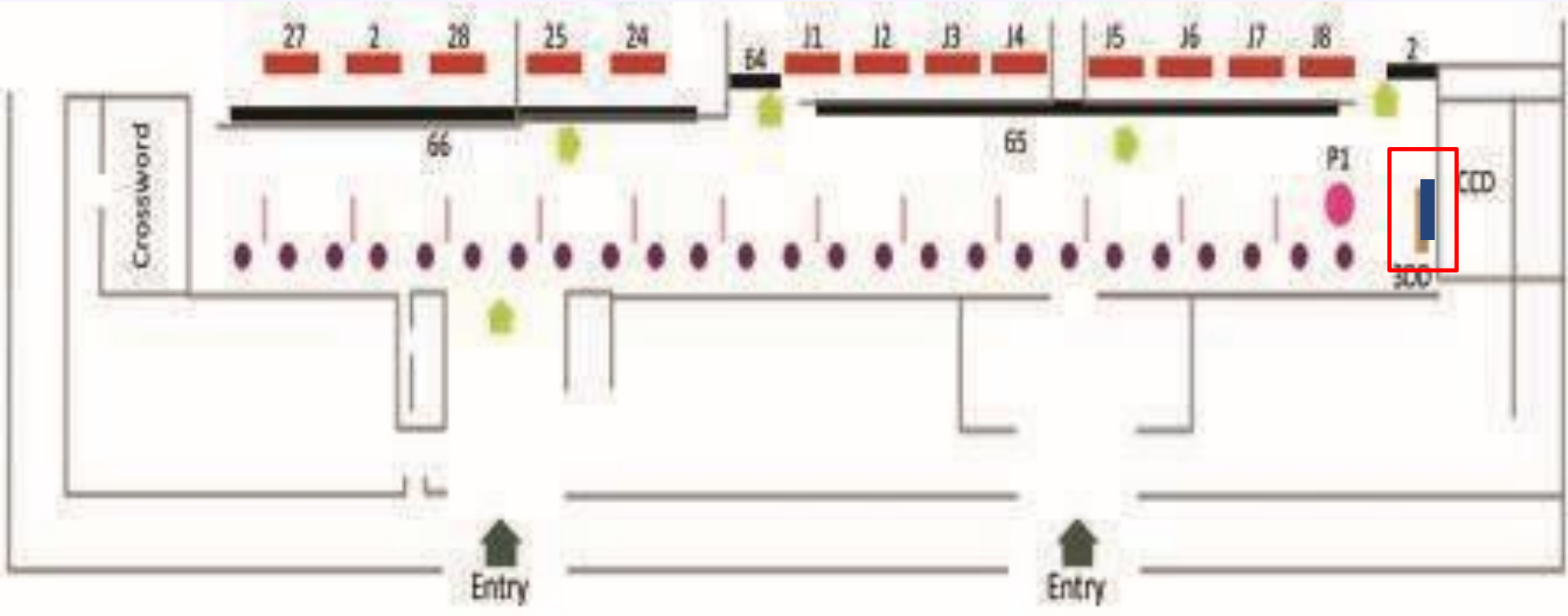

Cost Per Month 12,00,000 + GST



T1 B Departures, Overhead en route from check-in hall to SHA 2, Unit – 1, Size – 37 ft 2” (W) x 13 ft 7” (H), Static Ambient



Cost Per Month 14,00,000 + GST



T1 B Departures, Inside security hold area, on left wall, Unit – 1, Size – 57ft (W) x 14 ft 4" (H), SAV Ambient

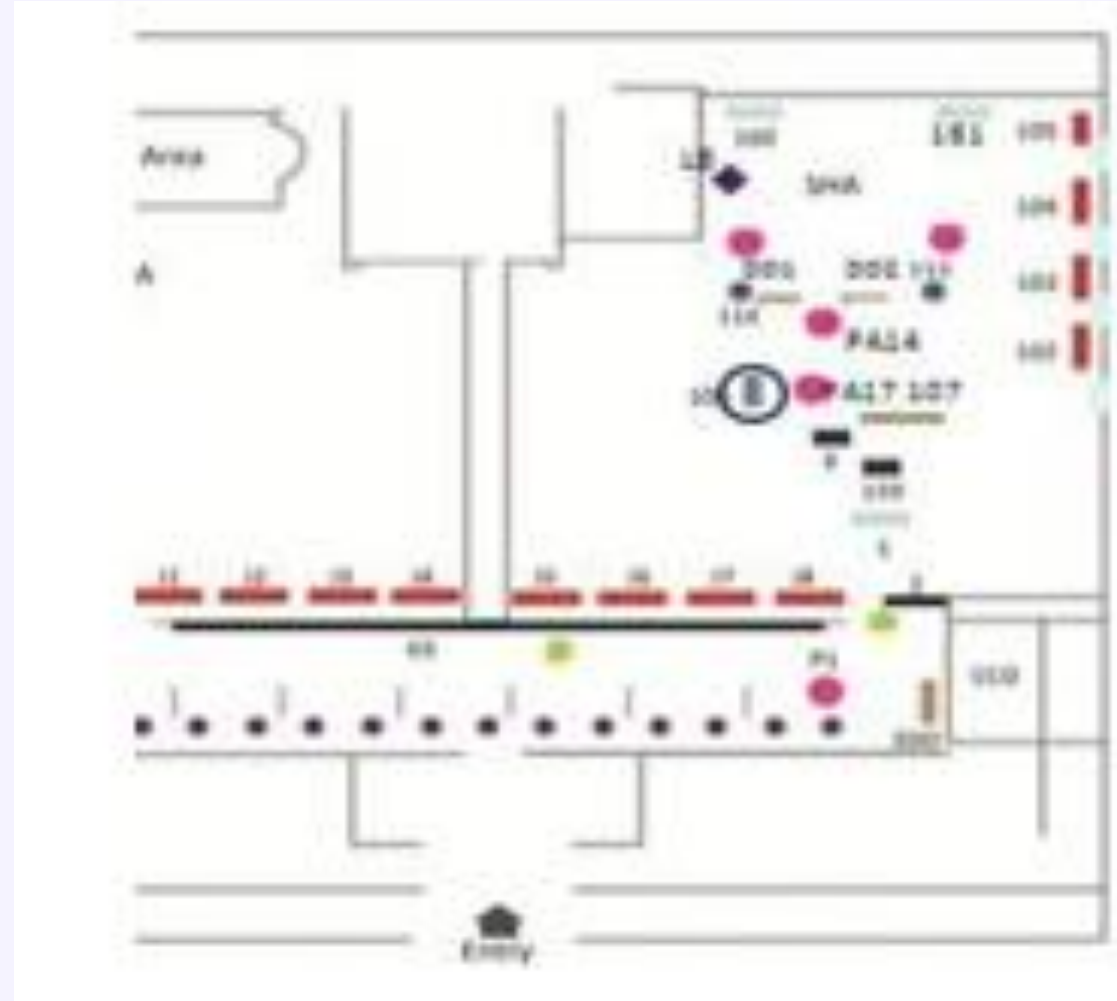

Cost Per Month 14,00,000 + GST



T1 C Departures, Eyelevel, Near female security check counter, Unit – 1, Size – 17 ft 4 inches (W) x 8 ft 5 inches (H), Backlit Static

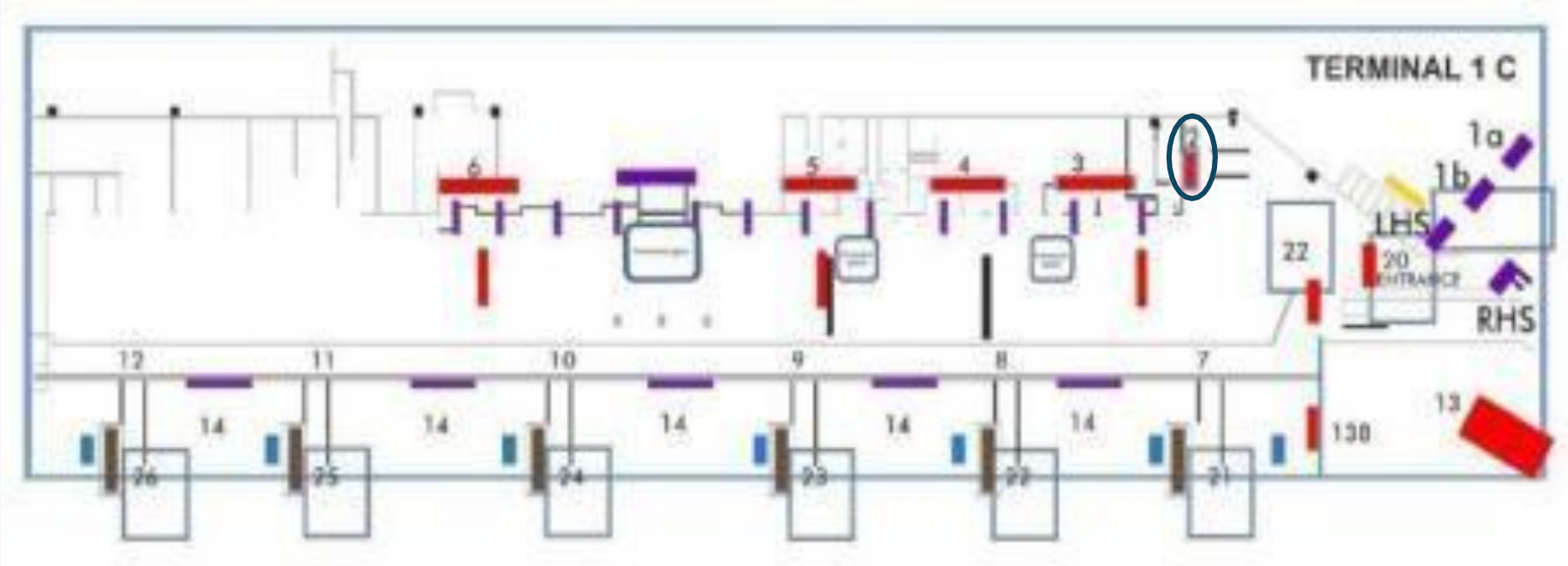

Cost Per Month 14,00,000 + GST



T1 C Departures, Panels adjacent to Retail Outlets, in Terminal 1C Departure Passage , Unit – 12 (Double Sided), Size – 11 feet 2 inches (W) x 2 feet 8 inches (H), Panel

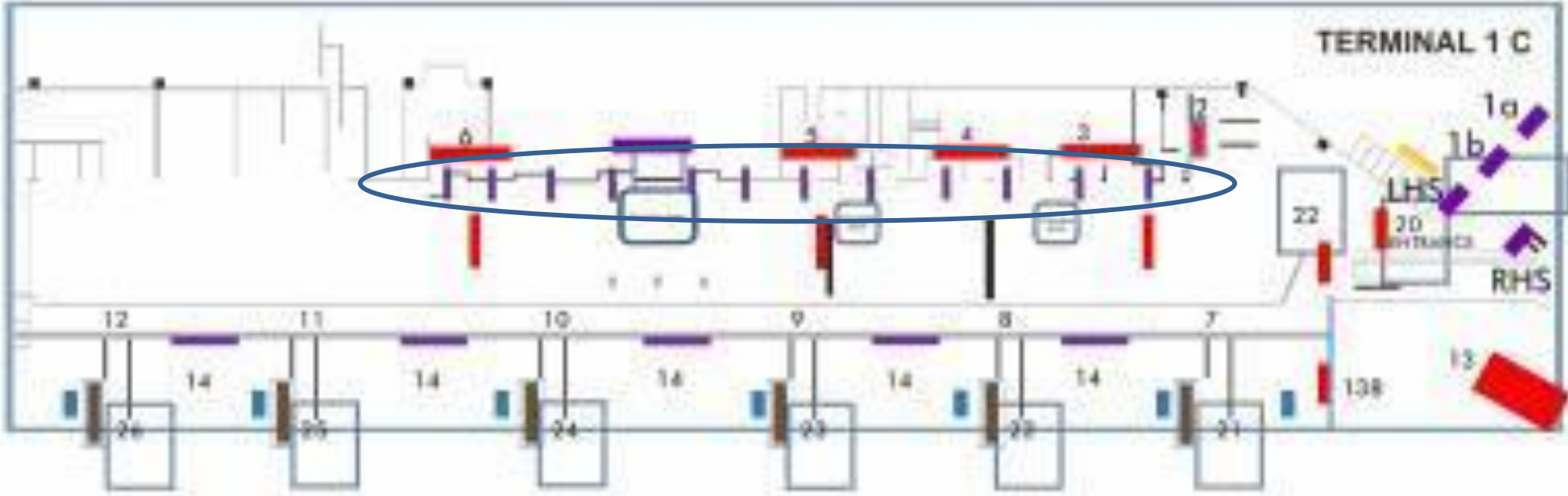



Cost Per Month 17,00,000 + GST



T1C Departure, On top of security check, Backlit dropdown, Unit - 1, Size – 24 feet 7 inches (H) x 9 feet 7 inches (H)

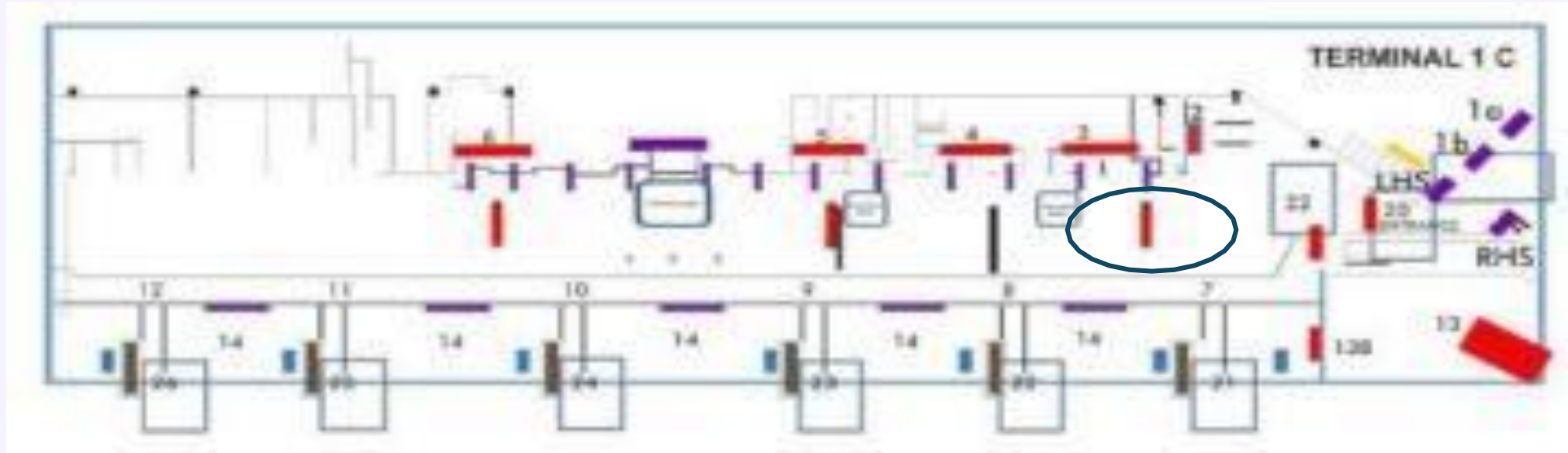

Cost Per Month 15,00,000 + GST



T1C Departure, On top of Coffee Bean, Backlit dropdown, Unit - 1, Size – 24 feet 7 inches (H) x 9 feet 7 inches (H)

Map View

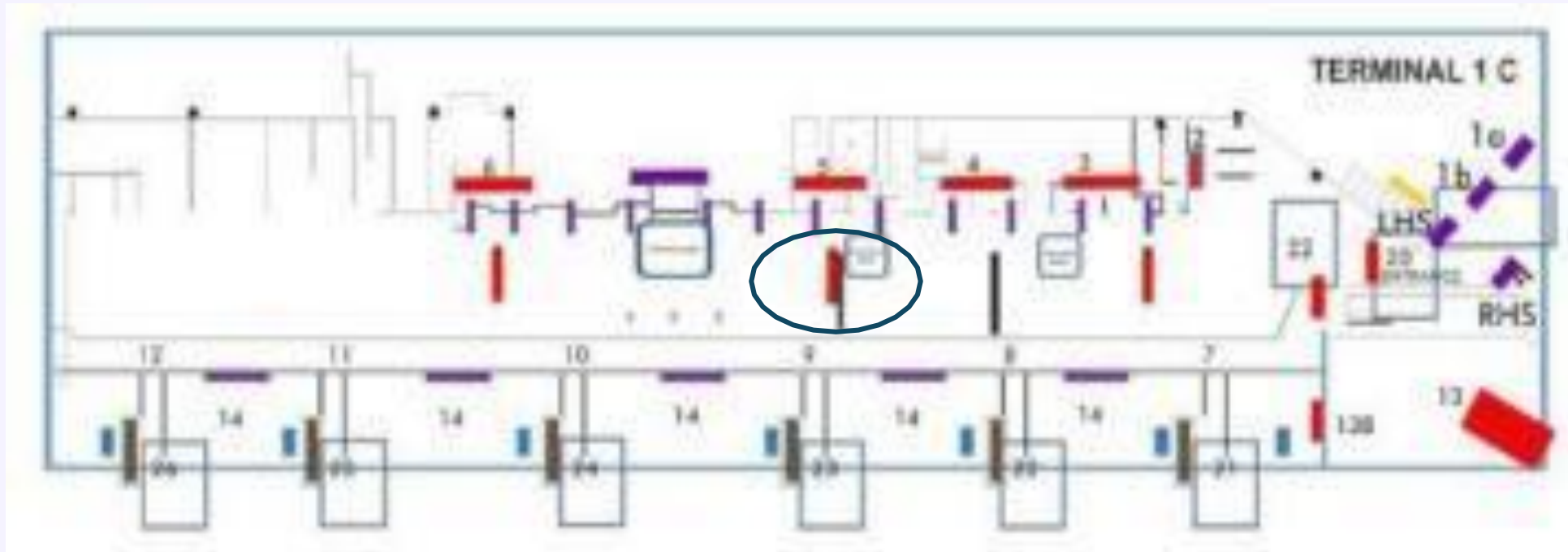

Cost Per Month 15,00,000 + GST



T1C Departure, On top of Ultra Bar, Backlit dropdown, Unit - 1, Size – 24 feet 7 inches (H) x 9 feet 7 inches (H)

Map View

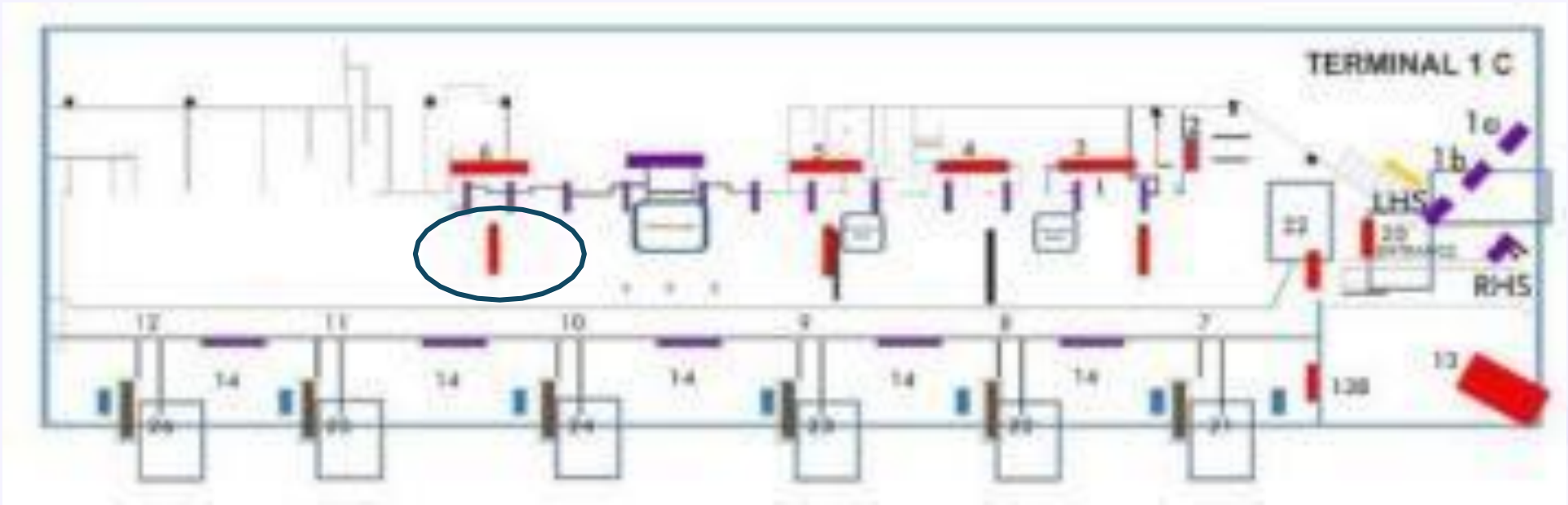

Cost Per Month 8,00,000 + GST



T1 Departures and Arrivals, Digital Screens, Unit - 7 screens, Size – 55”, LED – Loop Size – 10 Secs in every 90 secs

Map View

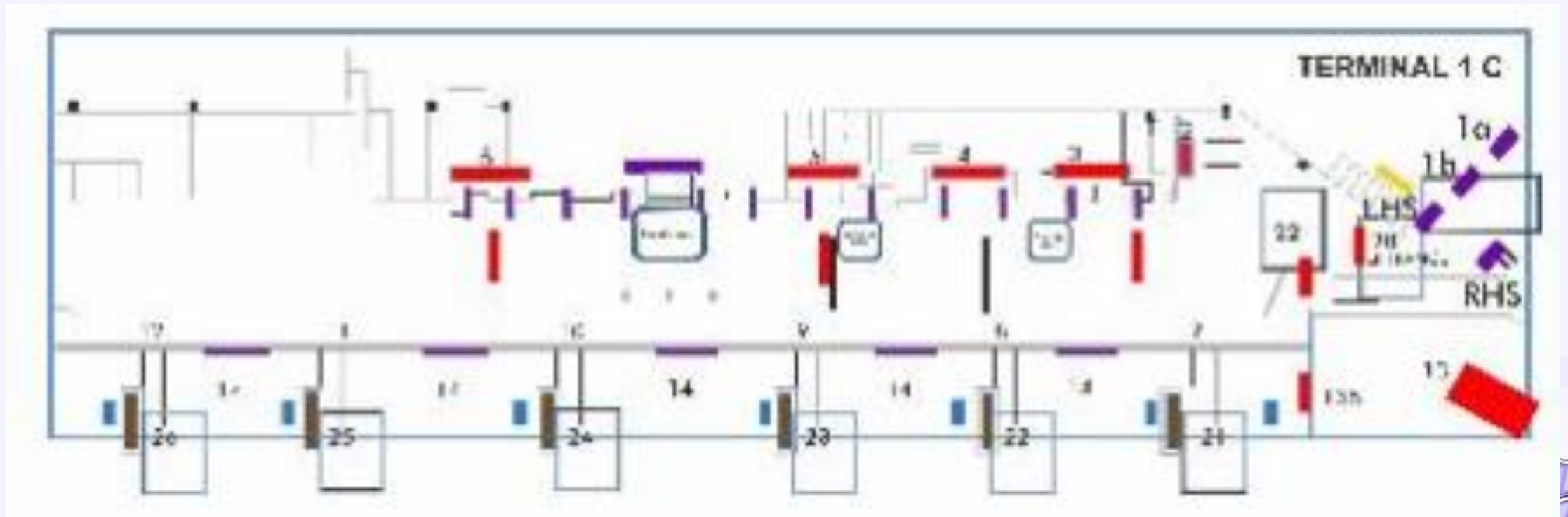

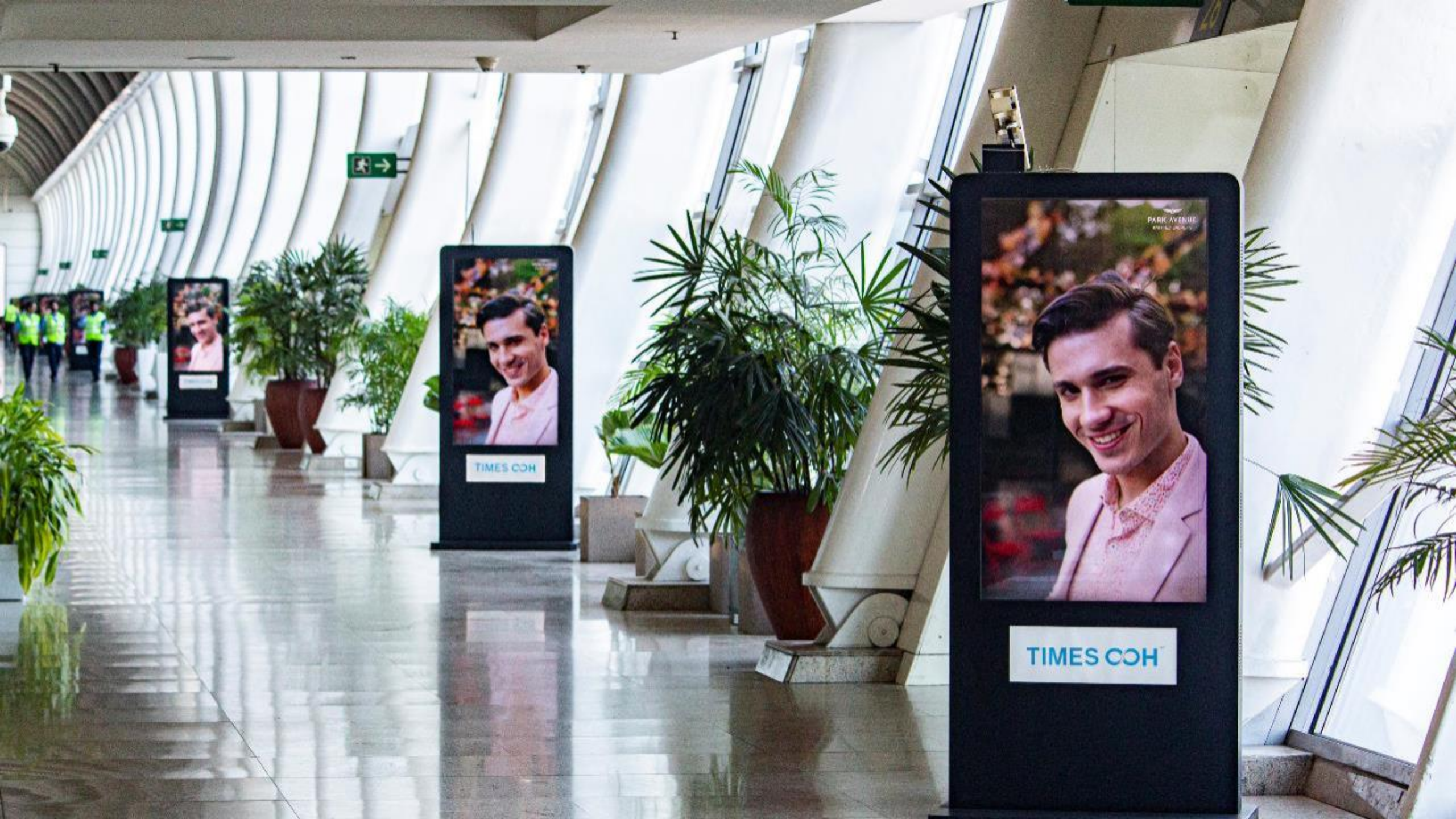

TIMES COH

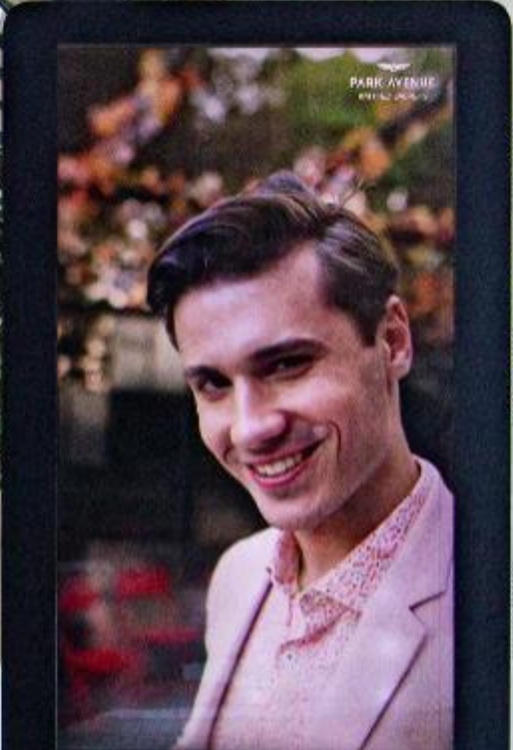

TIMES COH

Cost Per Month 18,00,000 + GST



T1 B Arrivals, 2nd site towards left of entrance of arriving passengers, Unit - 1, Size – 10 feet 5 inches (W) x 9 feet 5 inches (H), BackLit Static

Map View



Cost Per Month 13,00,000 + GST



T1B Arrival Conveyor Belt, Scroller, Unit - 5 screens, Size – 12 feet (W) x 3 feet(H), Loop Size – 10 Secs in every 60 secs

Map View



Cost Per Month 21,00,000 + GST



T1 Arrival , near arrival forecourt, Unit - 1, Size – 18 ft 10 in (W) x 9 ft(H), Backlit Static

Map View

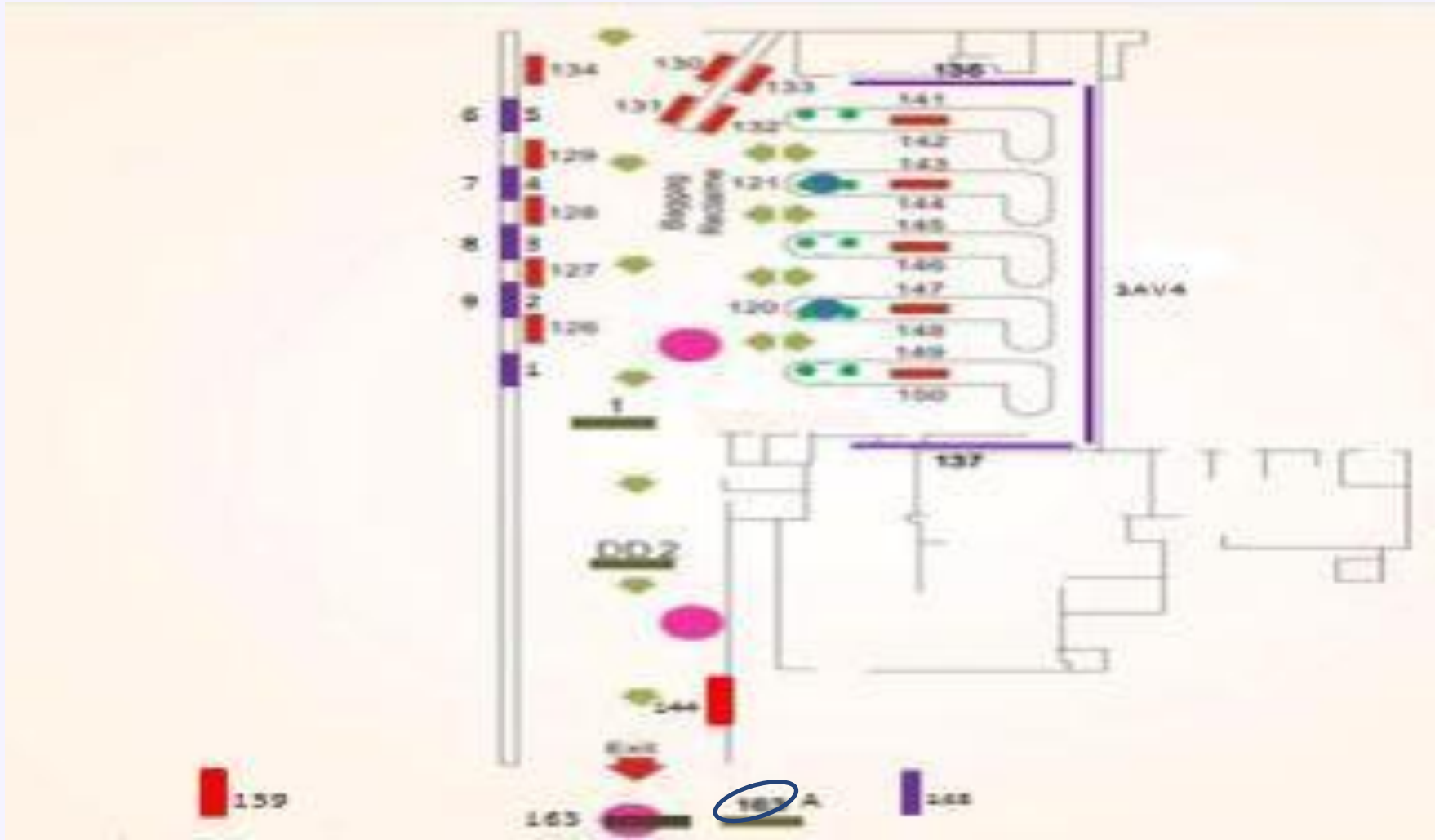

Cost Per Month 2,000 Per Trolley +
550 Per Trolley Production Charges
+ GST



Mumbai Luggage Trolley, Minimum Quantity - 100

Cost Per Month 9,35,000 +
Production Charges + GST



T1 D Arrival Corridor, Unit- 1, Size – 27.9 ft(W) x 6.9 ft(H), Static Backlit

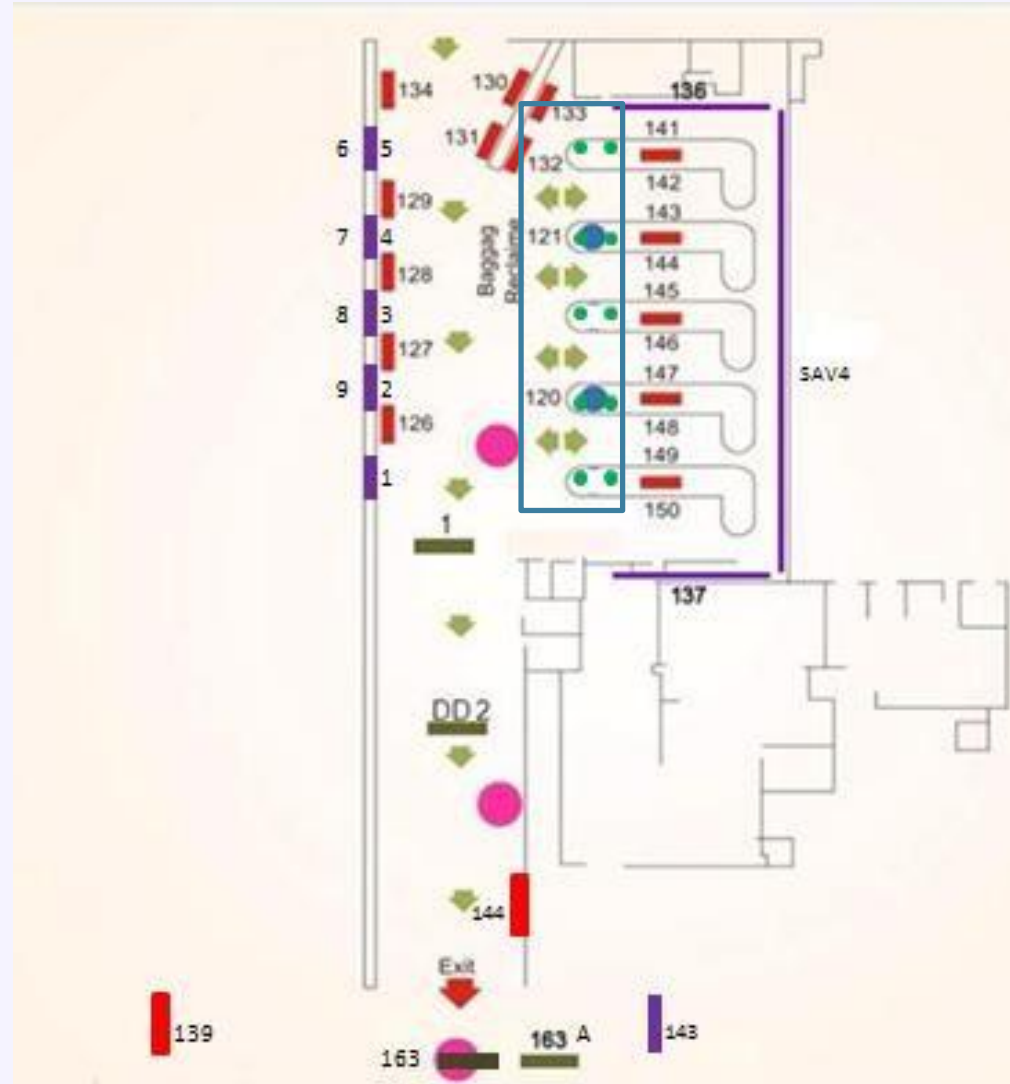

**Cost Per Month 17,00,000 +
43,624 Production + GST**

**Cost for 15 Days 8,50,000 +
43,624 Production + GST**



T1 B Domestic Arrival Entrance, Unit – 1 (Double Sided), Size – 14.6 ft X 16.6 ft, Drop Down Hoarding

Cost Per Month 23,00,000 +
Production + GST



T1B Departure, Sitting Area Security Hold Area, Unit – 1 (Double Sided), Size – 25 ft X 20 ft, Overhead Drop Down

Cost Per Month 24,00,000 + GST



T2 International Departure, Retail Area – Opposite Delsey Store, Unit- 1, Size – 8 X 8 ft, Promo Space

MAP VIEW

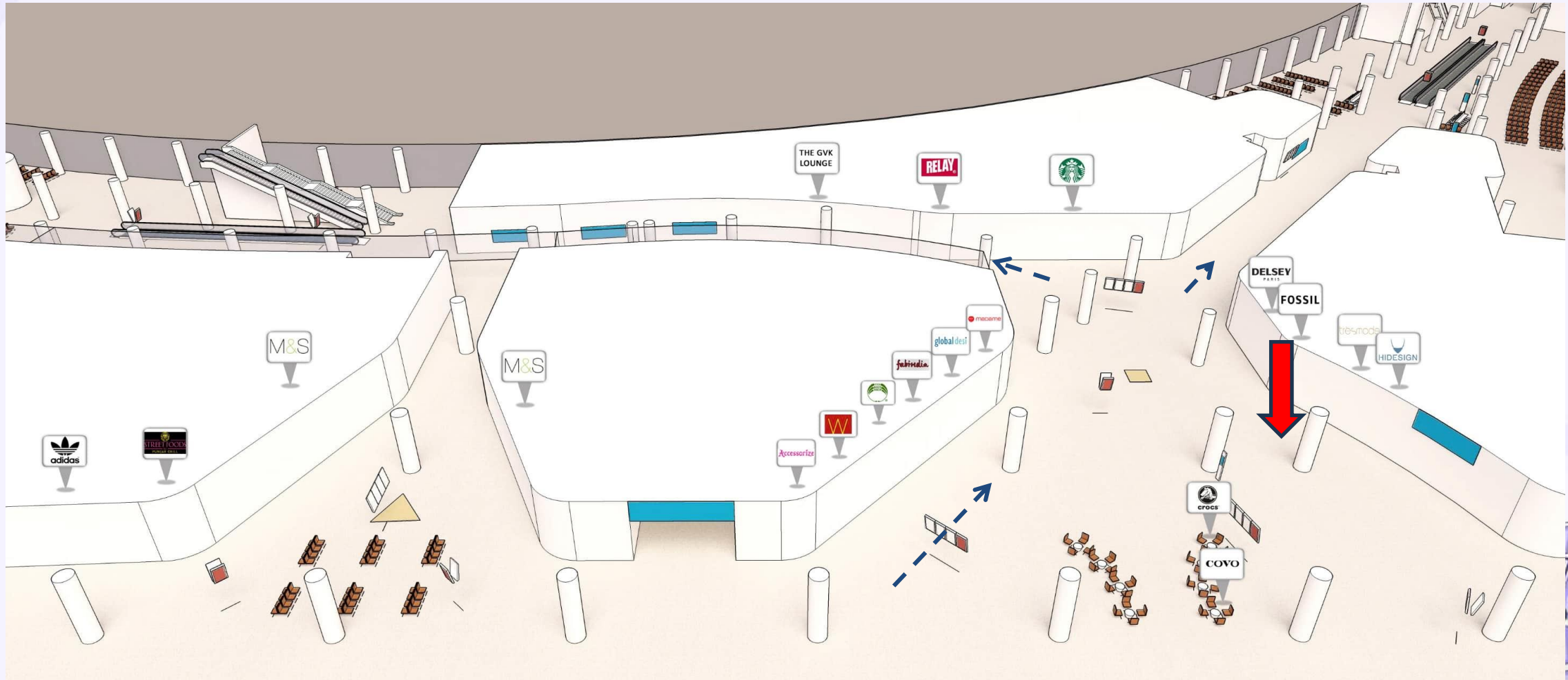

Cost Per Month 24,00,000 + GST



T2 International Departure, Retail Area – Opposite to Lacoste, Unit- 1, Size – 10 X 10 ft, Promo Space

MAP VIEW

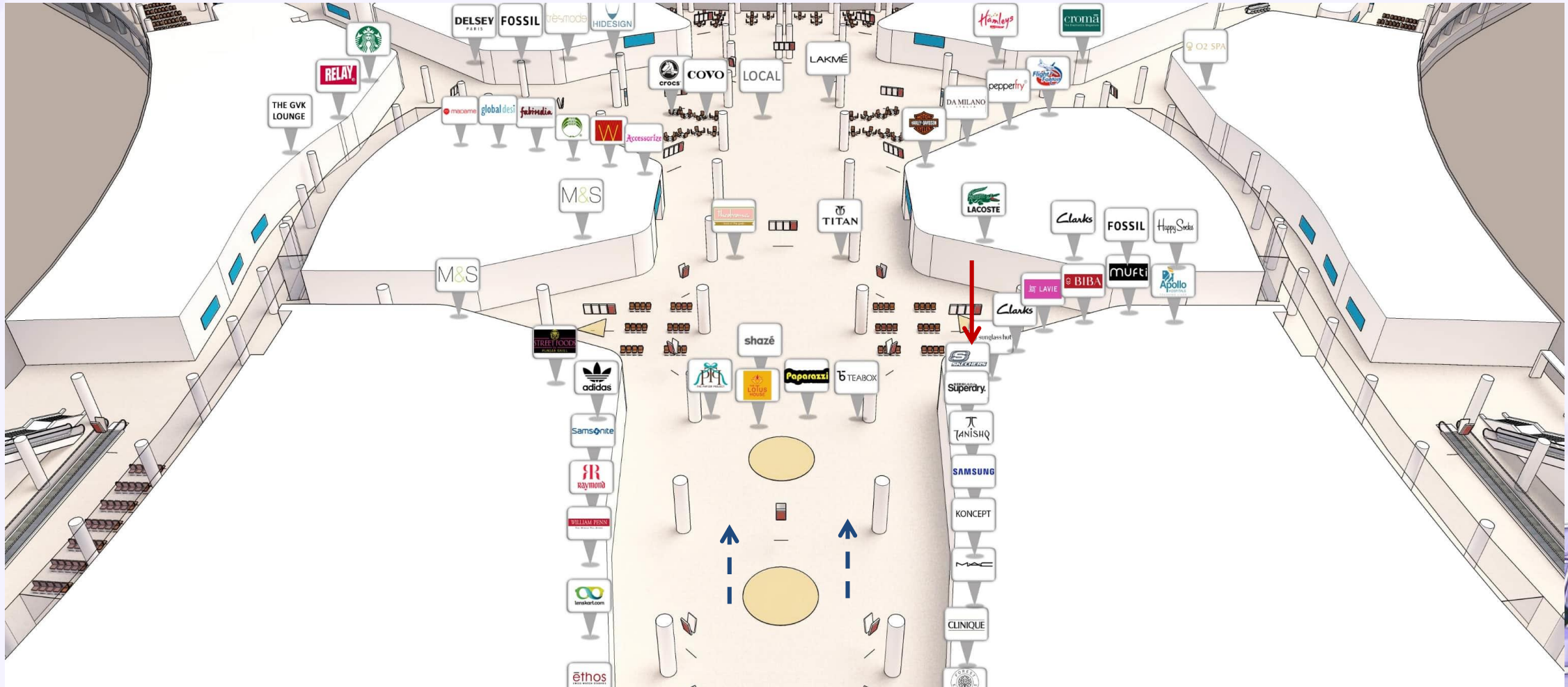

Cost Per Month 35,00,000 + GST



Departure Retail Section Between Theobroma, Zone – 7, Unit – 1, Size – 20ft (W) X 15ft (D), Radius- 300 sqft

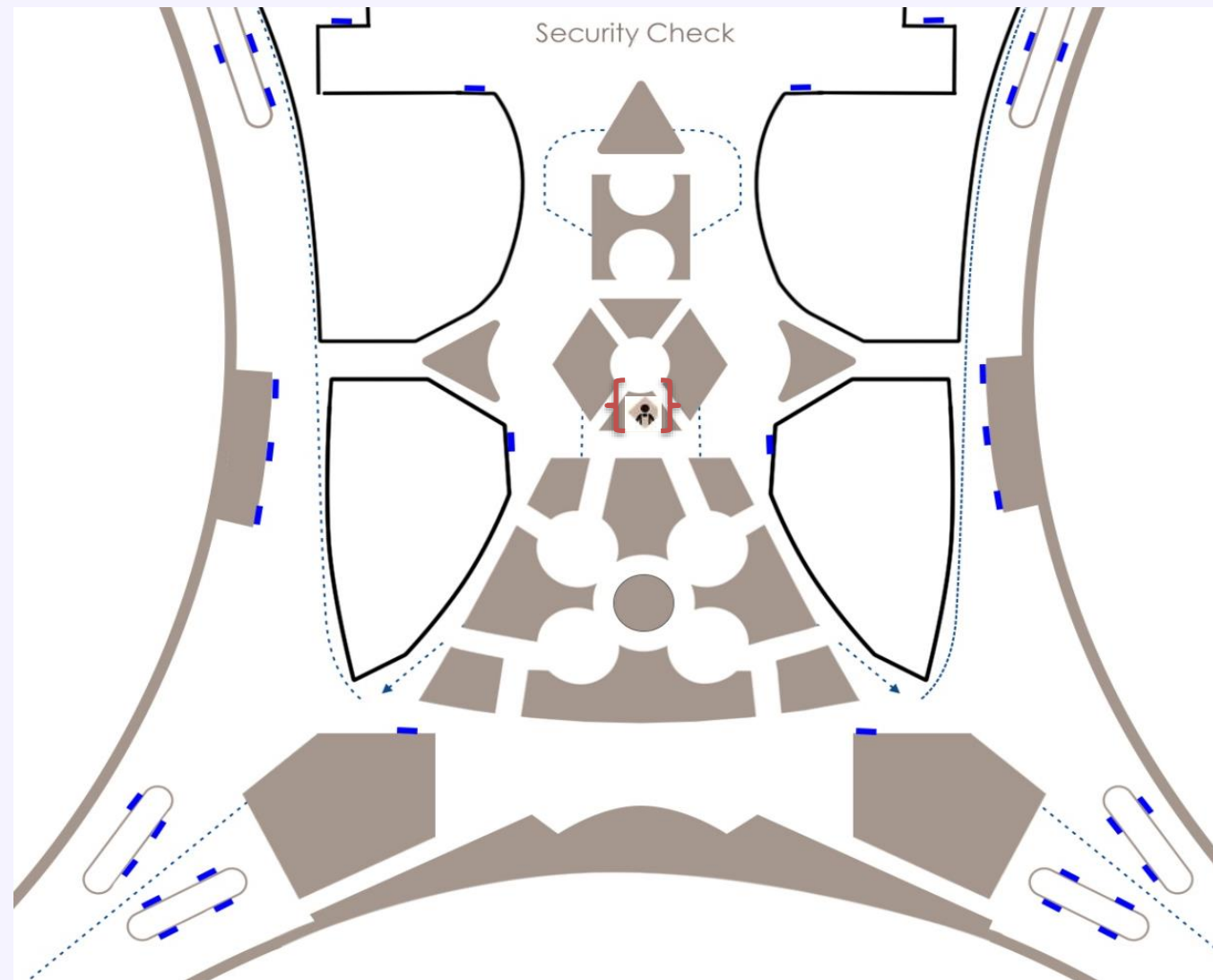

Cost Per Month 80,00,000 + GST



Common Kerbside Arrivals – Opposite to Gate B., Unit – 1, Size – 20ft (W) X 5ft (D) X 13ft (H)

Map View

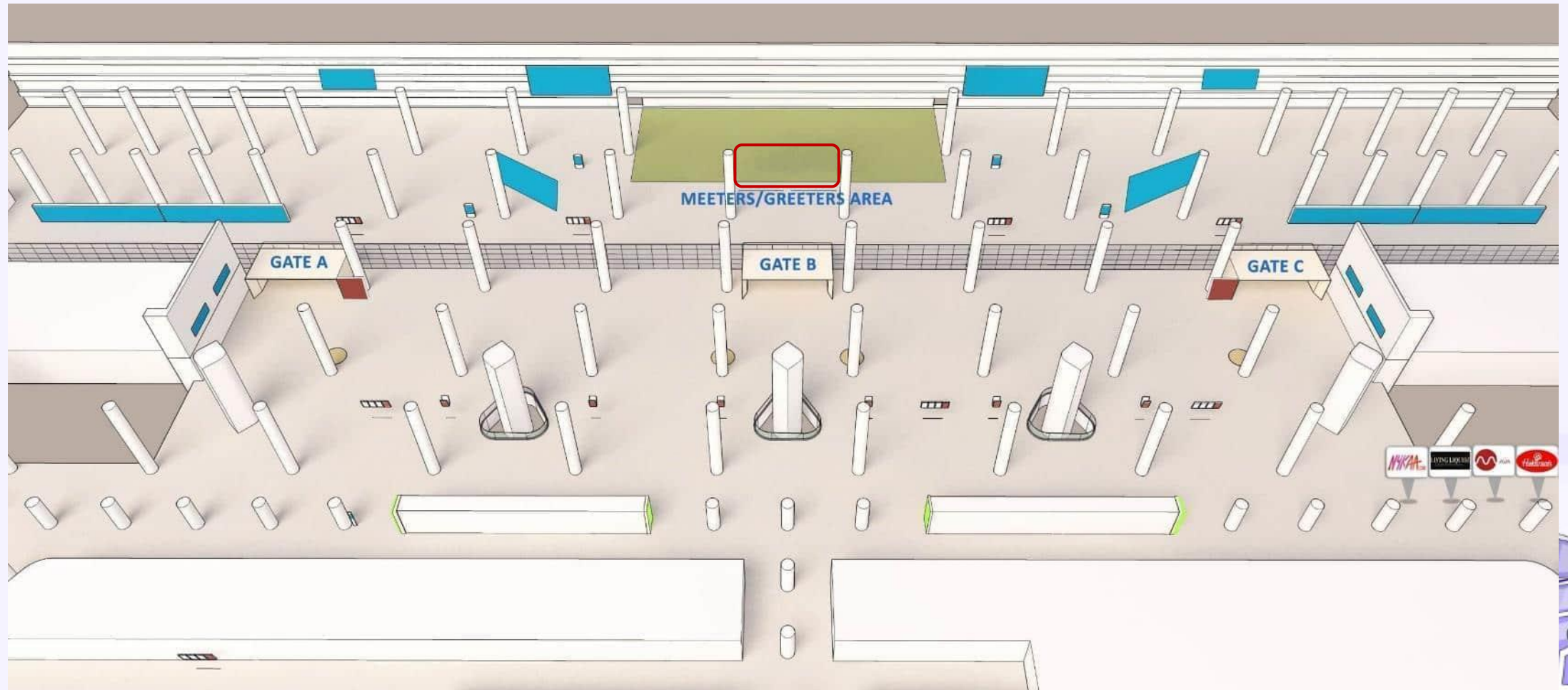

Cost Per Month 5,000,000 + GST



T2 DOMESTIC & INTERNATIONAL CHECKIN
Unit – 7, Size – 12ft X 8ft , 30 Sec in 180 Sec Loop

Map View

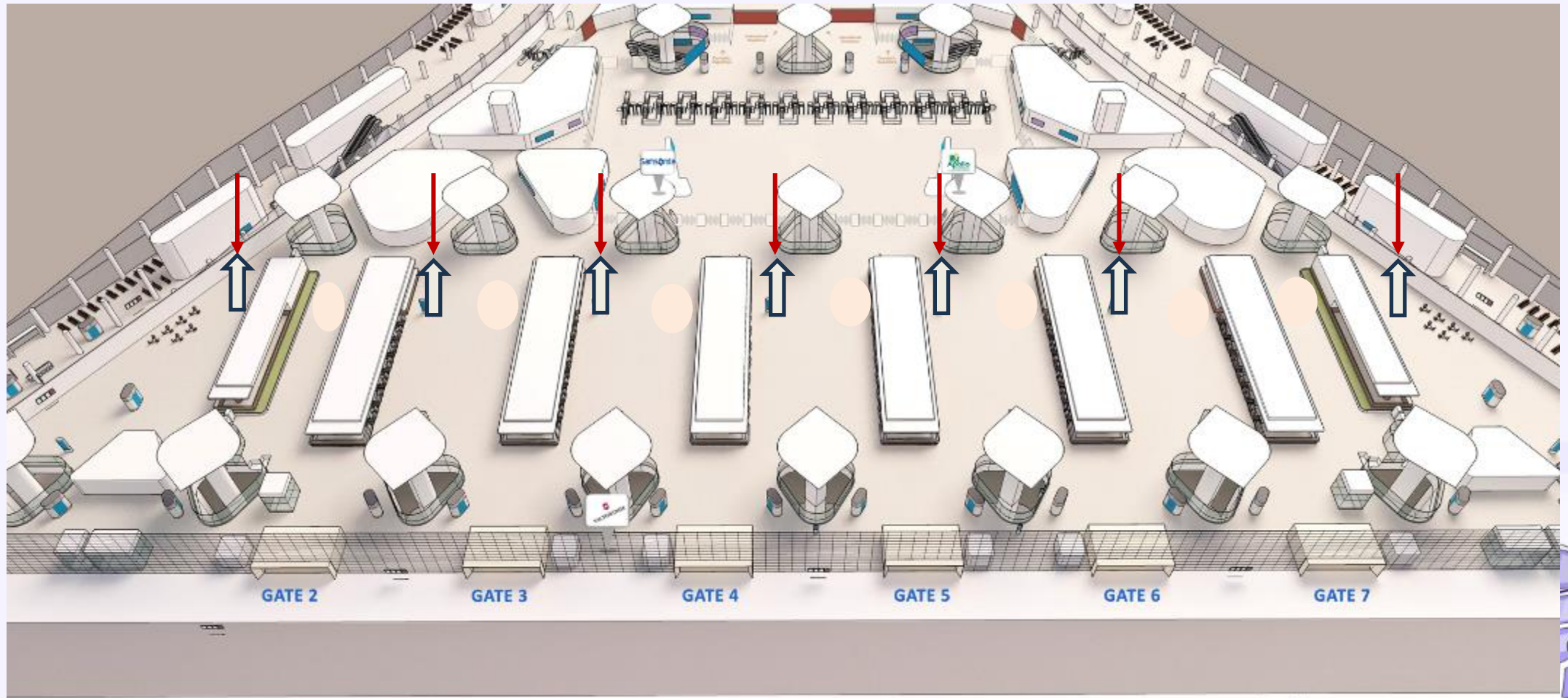



ROUGE DIOR
ON STAGE
STAGE-PROOF ULTRA WEAR
SHINE LIPSTICK



Cost Per Month 5,000,000 + GST



T2 DOMESTIC DIGITAL PANORAMA L3 DOMESTIC SHA
Unit – 1, Size – 80ft X 6ft , 10 Sec in 60 Sec Loop

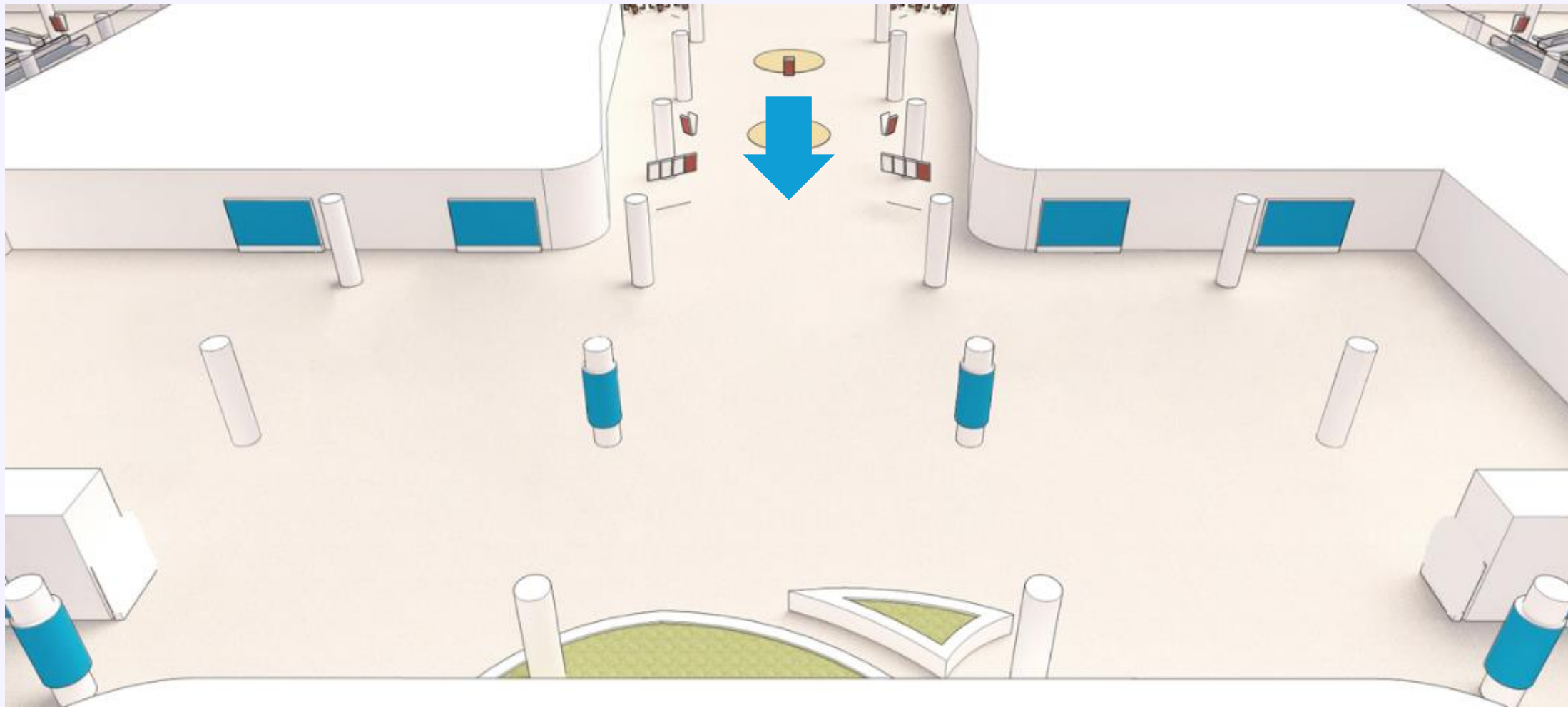

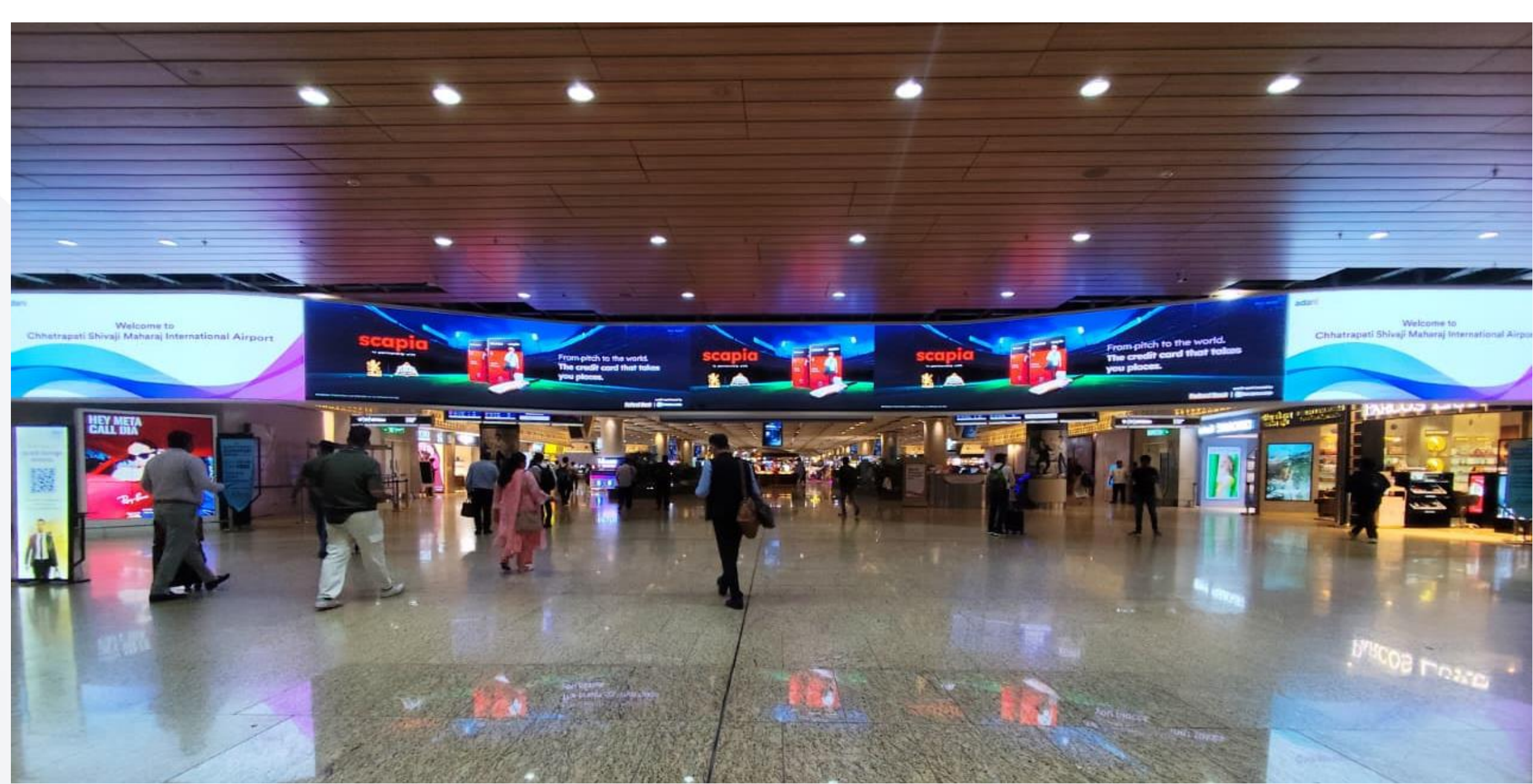

Welcome to
Chhatrapati Shivaji Maharaj International Airport

scapia

From pitch to the world.
The credit card that takes
you places.

scapia

scapia

From pitch to the world.
The credit card that takes
you places.

Welcome to
Chhatrapati Shivaji Maharaj International Airport

**HEY META
CALL DIA**

adani



L2 ARRIVAL BAGGAGE BELT AREA, Unit- 2, 30 x10 ft , T2

adani

Chhatrapati Shivaji Maharaj
International Airport Mumbai

Land your brand
in the spotlight.



Scan to
advertising here.



13

17

11

10



Map View

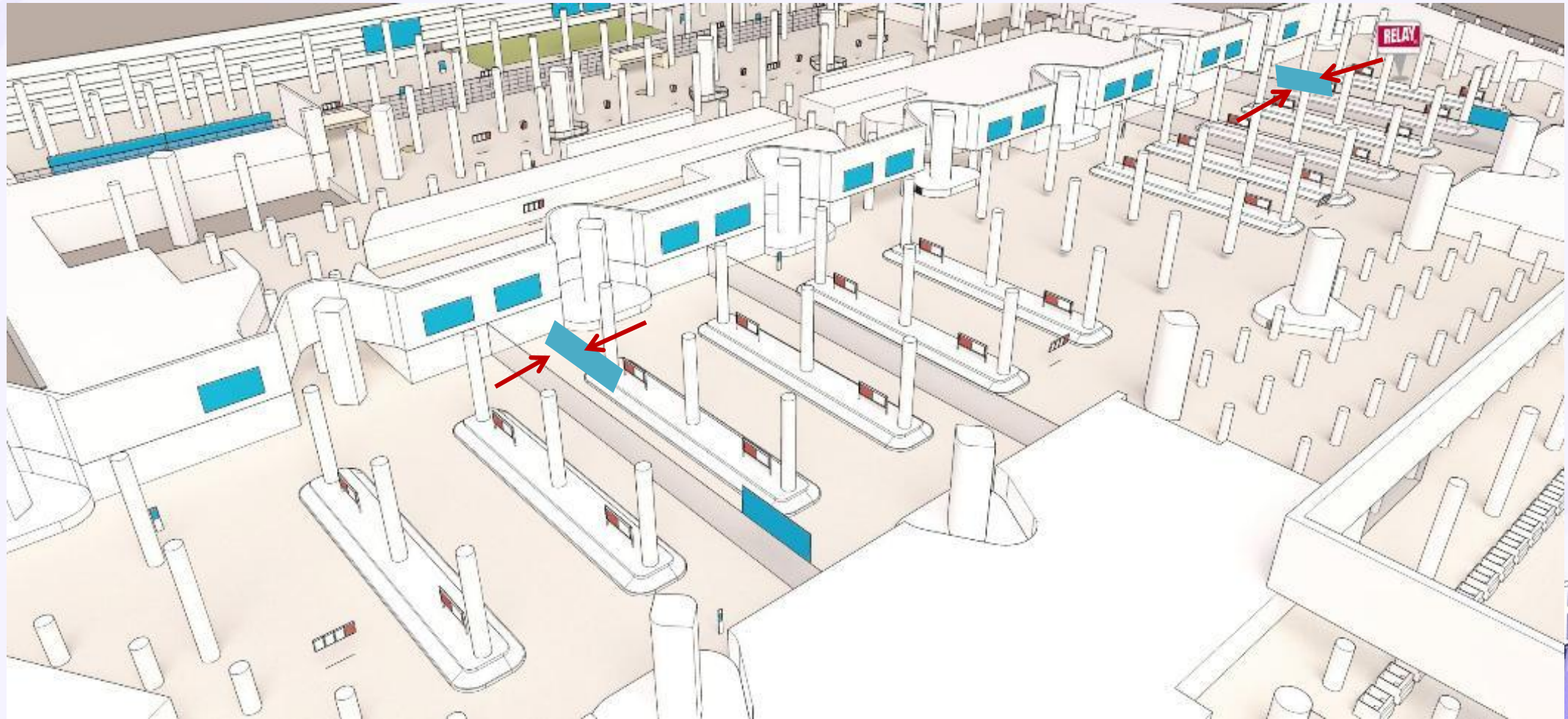

Cost Per Month 5,000,000 + GST



T2 DOMESTIC ARRIVAL VIDEOWALL WAVE L2 ARRIVAL BAGGAGE BELT AREA
Unit – 2, Size – 90ft X 10ft , 10 Sec in 60 Sec Loop

Map View

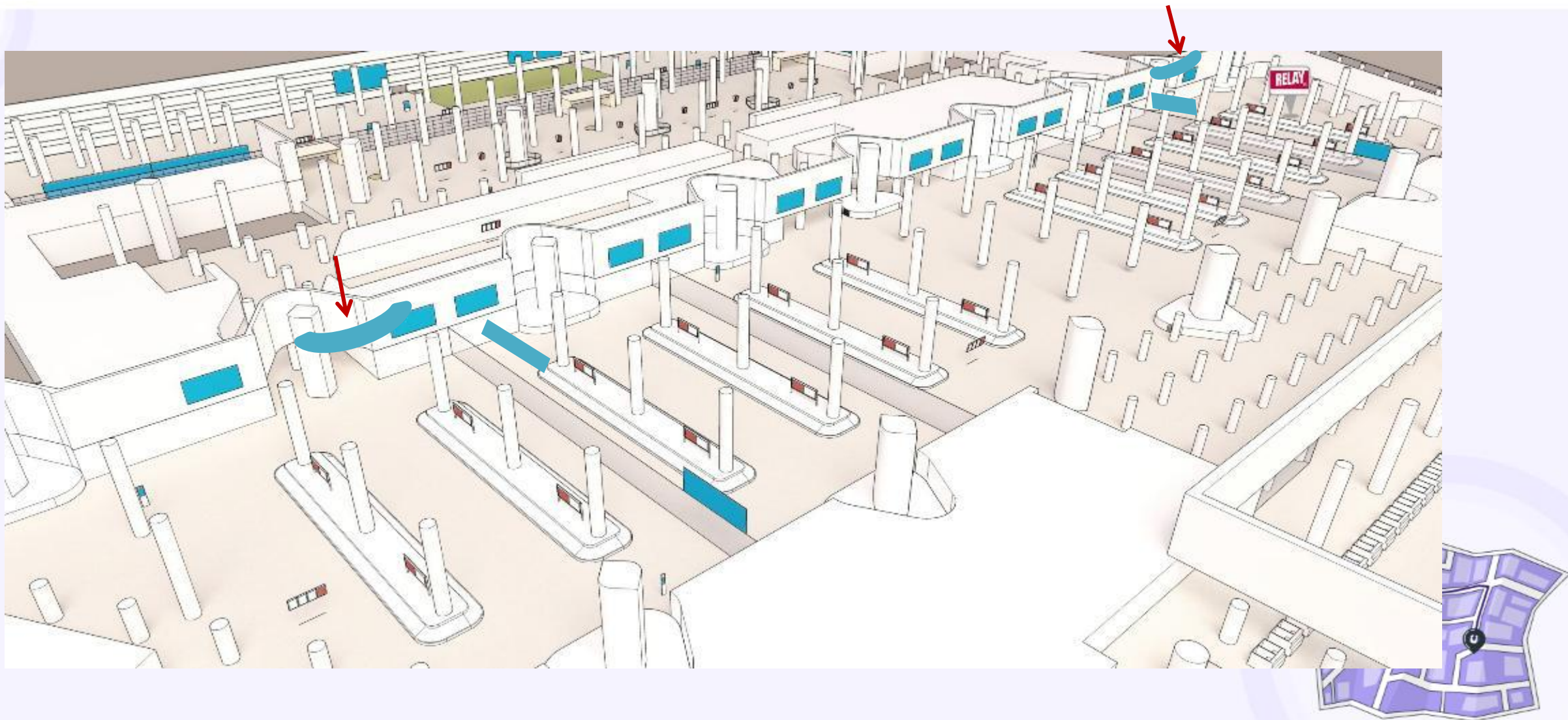



Cost Per Month 4,500,000 + GST



T2 DOMESTIC MOTION X (KINETIC VIDEO WALL) L2 ARRIVAL POST BAGGAGE BELT AREA
Unit – 3, Size – 10.5ft X 14ft , 10 Sec in 30 Sec Loop

Map View

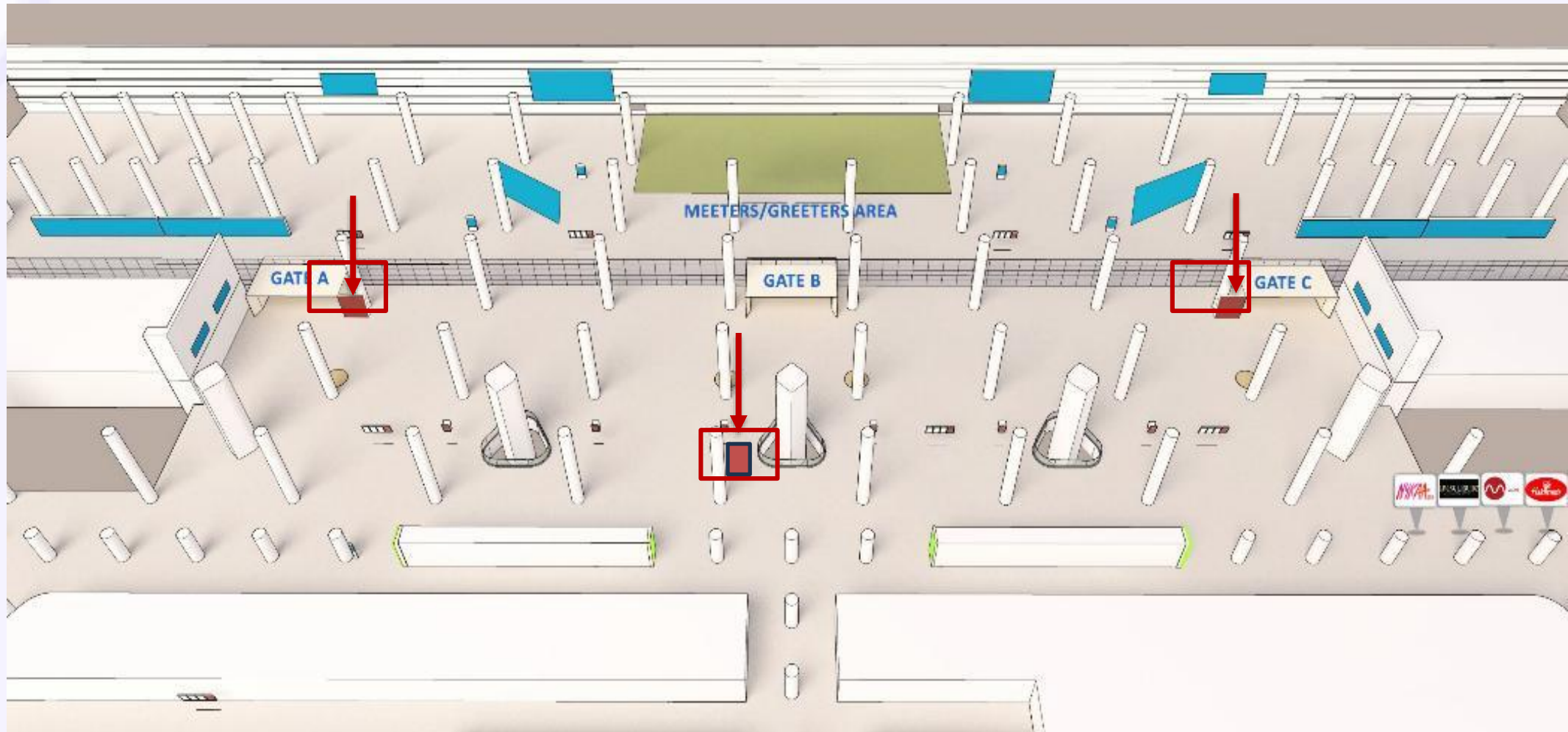



Cost Per Month 18,00,000 + GST



T2 DOMESTIC DIGITAL CHECK IN HALL – OUTSIDE RESERVE
Unit – 1, Size – 15ft X 25ft , 10 Sec in 60 Sec Loop

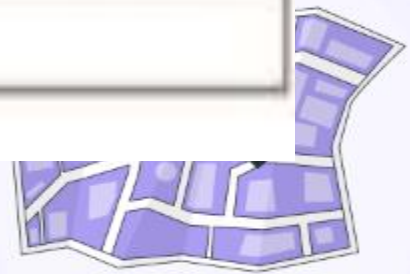
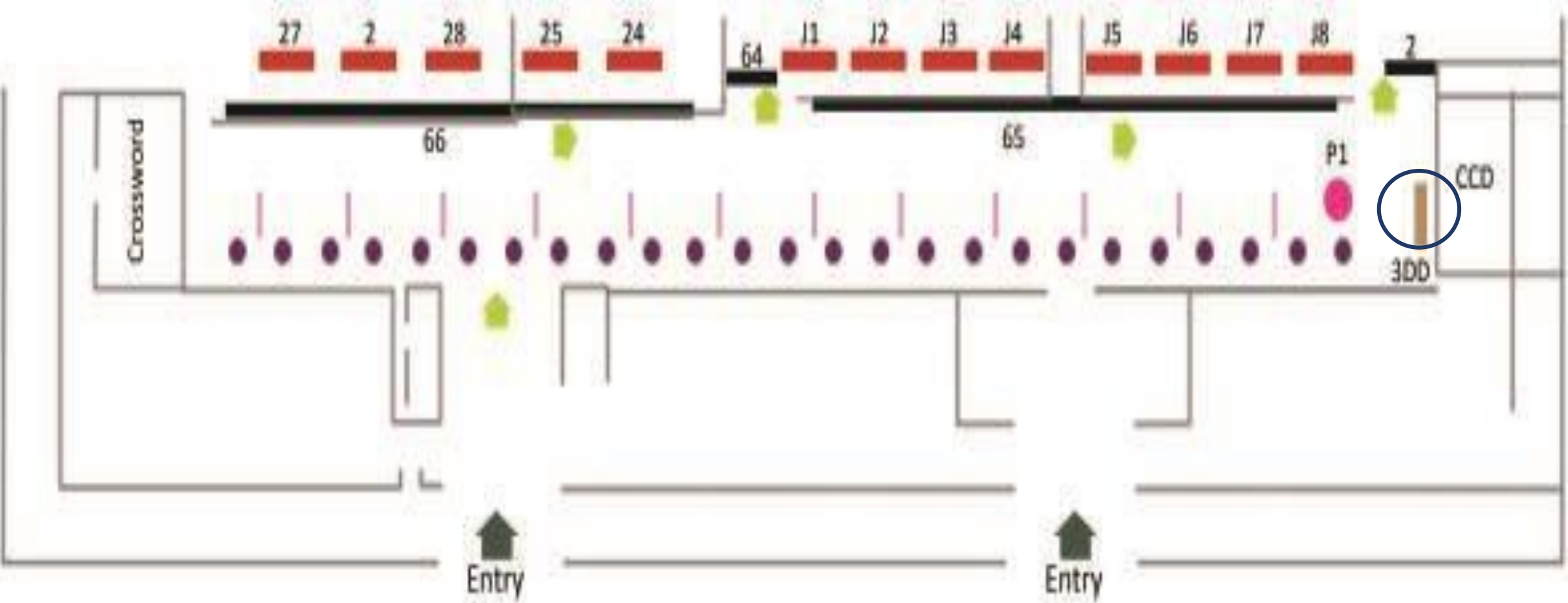

HEY META
CALL DIA



कॅफ़े कॉफ़ी डे CAFE COFFEE DAY

Boarding Gate No. / बोर्डिंग गेट नं. → Lift | लिफ्ट
← 09-20 | 21-31 →

Security Check Gates 21 to 31

Reserved Lounges

Cost Per Month 36,00,000 + GST



**T2 DOMESTIC DIGITAL GANTRY Departure – Arrival
Unit – 1 (Double Sided), Size – 75ft X 10ft , 20 seconds/ 80 seconds' loop**

Map View

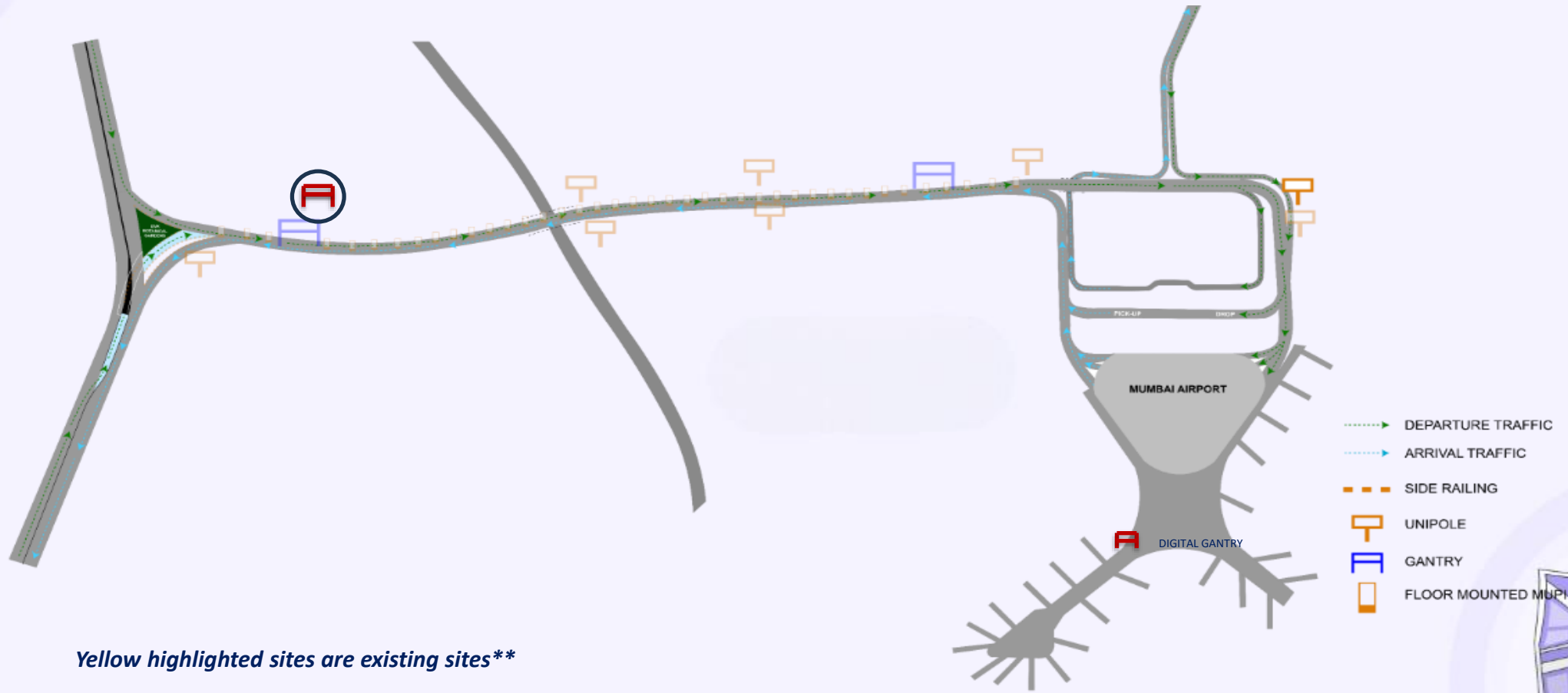

*Yellow highlighted sites are existing sites***





	 बंदी बंदी Bandra	 <p>The new Audi SQ8 Best of both worlds.</p>	 <p>Fires your pulse. Steadies your nerves.</p>
	 मंत्रालय मंत्रालय Mantralaya		
	 अंधेरी अंधेरी Andheri		

 AVAADA
 FRESH GREEN ENERGY
 SOUND THE FLORA.

KHELENGE
CELEBRITIES,
JEETENGE AAP!



THE
50

NEW EPISODE EVERY DAY

JioHotstar
9:00 PM

colors
10:30 PM



07/02/2026

Cost Per Month 10,00,000 + GST



T2 DOMESTIC TOTEM OUTDOOR – DEPARTURE

Unit – 16 Units (8 Unit at Departure and 2 unit Double sided) at Arrivals, T1 Arrivals 2 units Double sided , T1 Departure 2 units (WIP),
Size – 7ft X 10ft , 15 sec spot in 2 mins

Map View

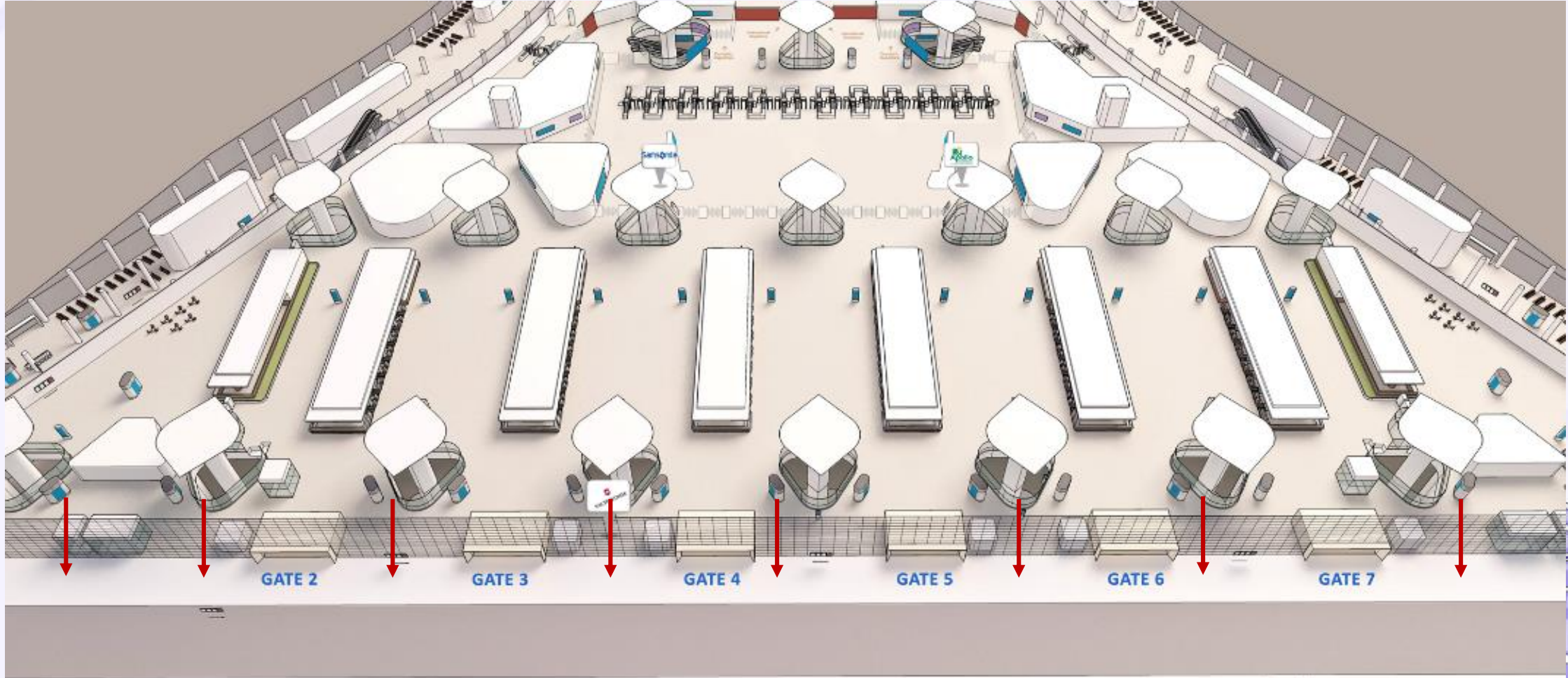

Map View

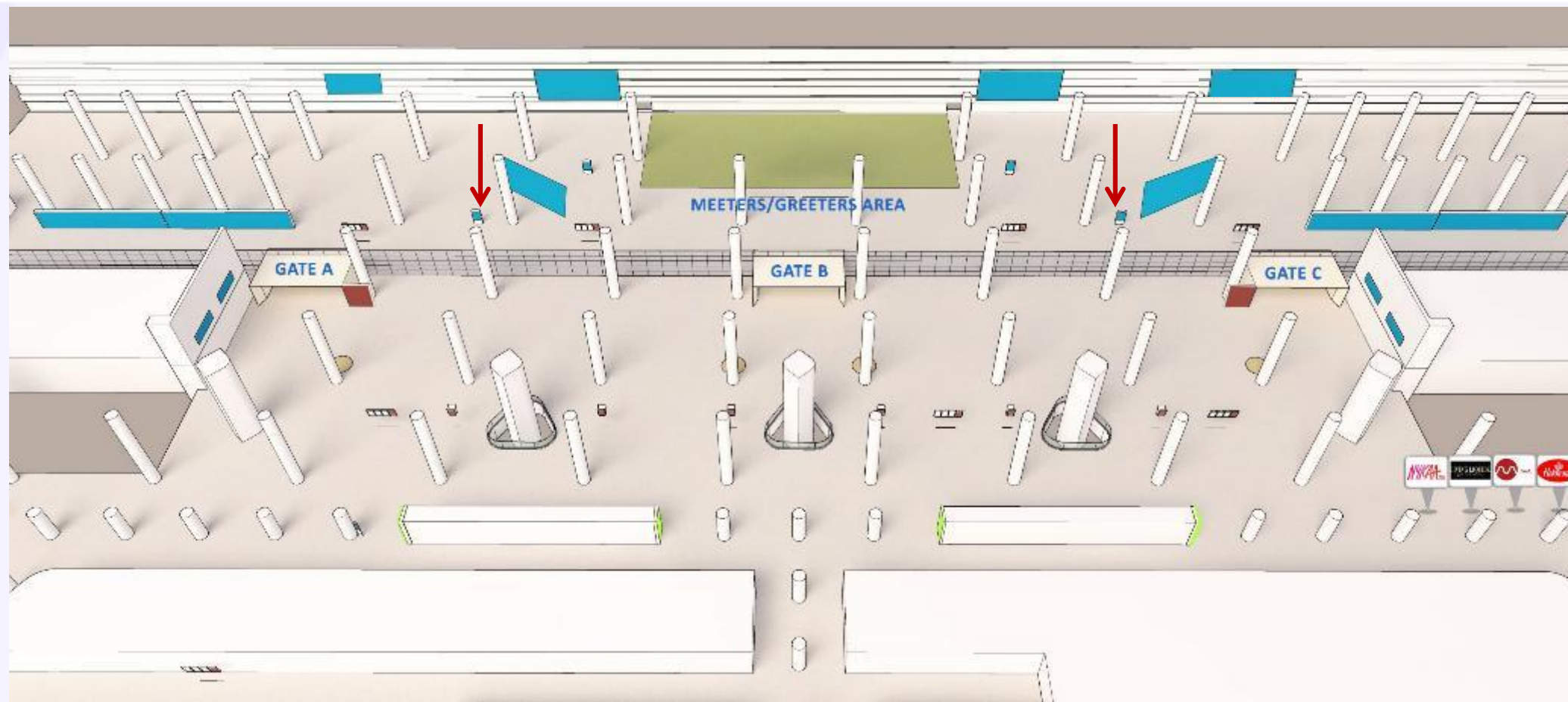

Cost Per Month 25,00,000 + GST



T2 International Arrival Video Wall
Unit – 1, Size – 21ft X 7ft , 3 Slots - 10 sec slot in 30 sec loop

Map View

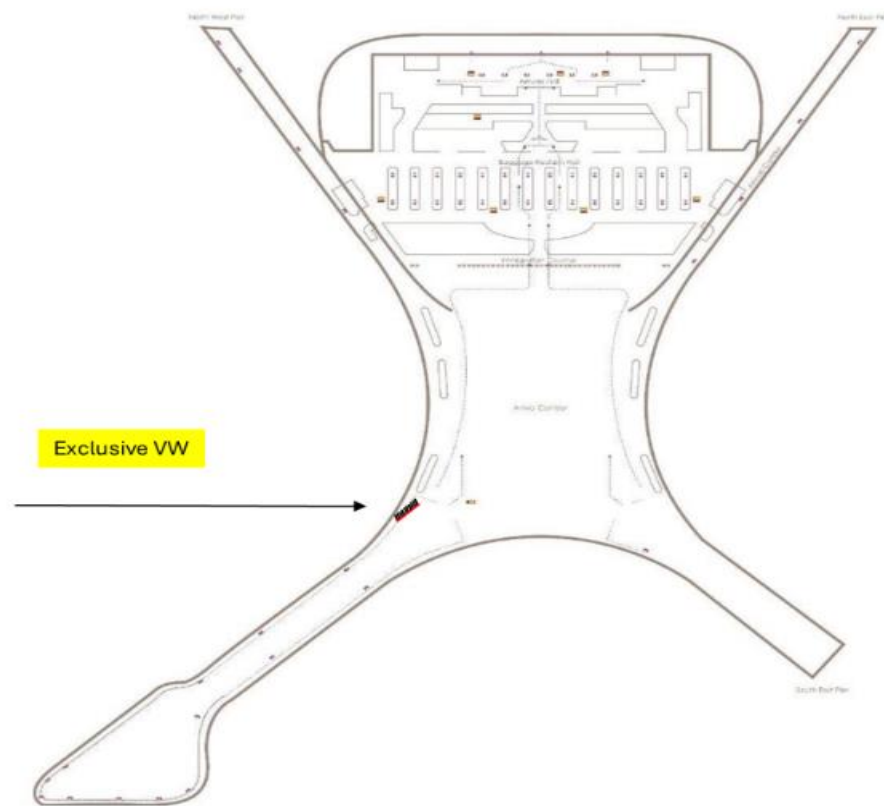



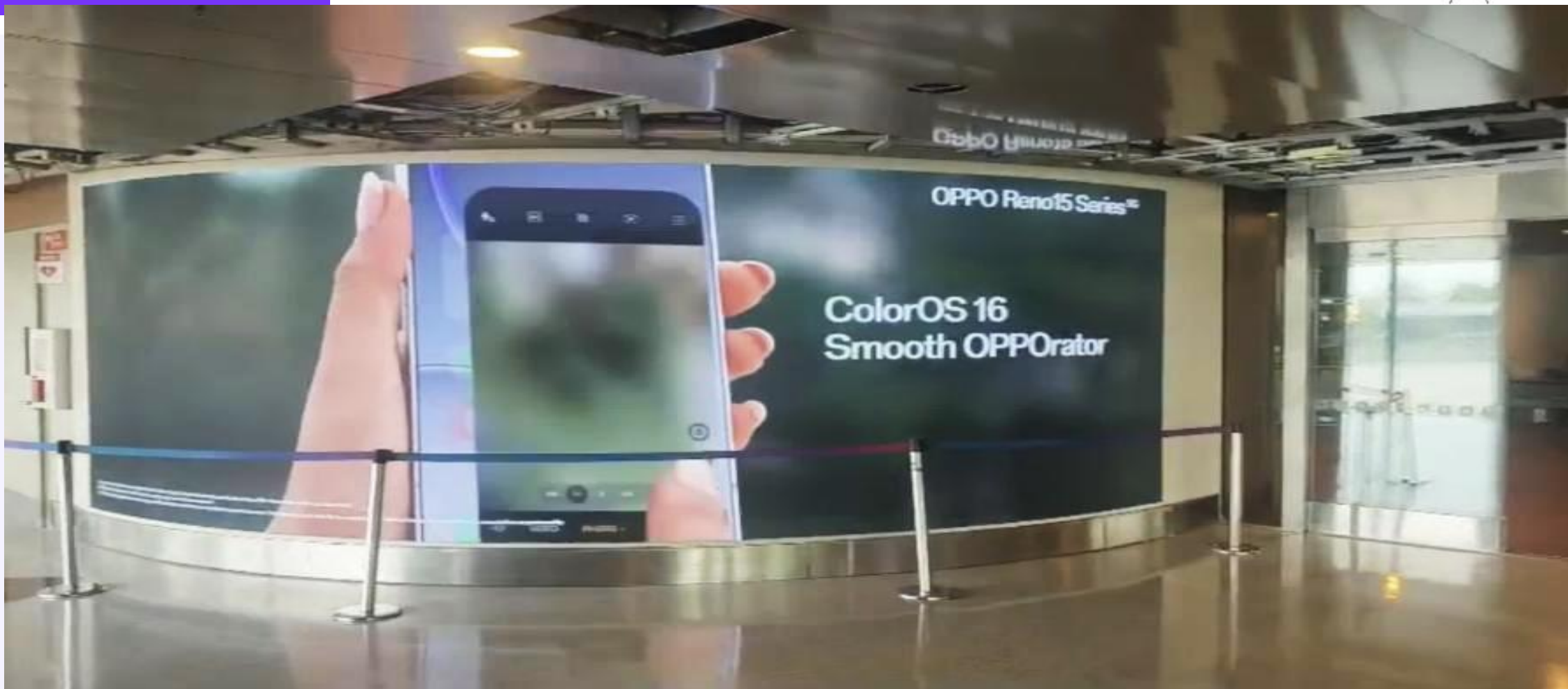

Cost Per Month 60,00,000 + GST

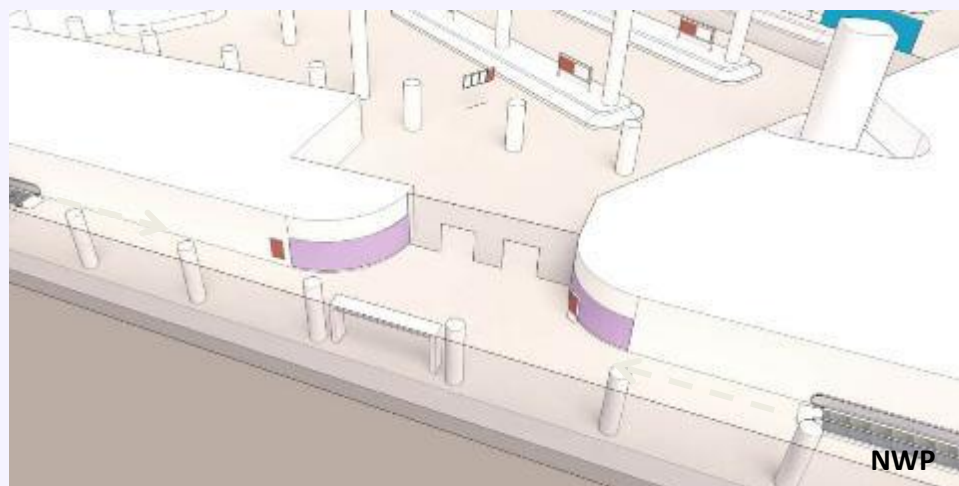

**U-Shaped Video Wall DOMESTIC ARRIVALS CORRIDOR
Unit – 4, 75% SOV 45 sec in 1 min slot (15 sec will Airport creative)**

Map View



-  Denotes the media
-  Denotes the direction of Passenger flow





Cost Per Month 35,00,000 + GST



COMMON ARRIVALS BIDS Digital Screens T1 & T2 ARRIVALS
Unit – 66 Units (56 in T2 &10 in T1) Size -108 Inch (5 ft * 8 ft) BIDS Size:- 1.5ft * 8 ft, 10 Sec in 2 Min

Map View

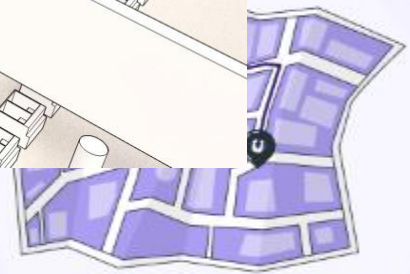
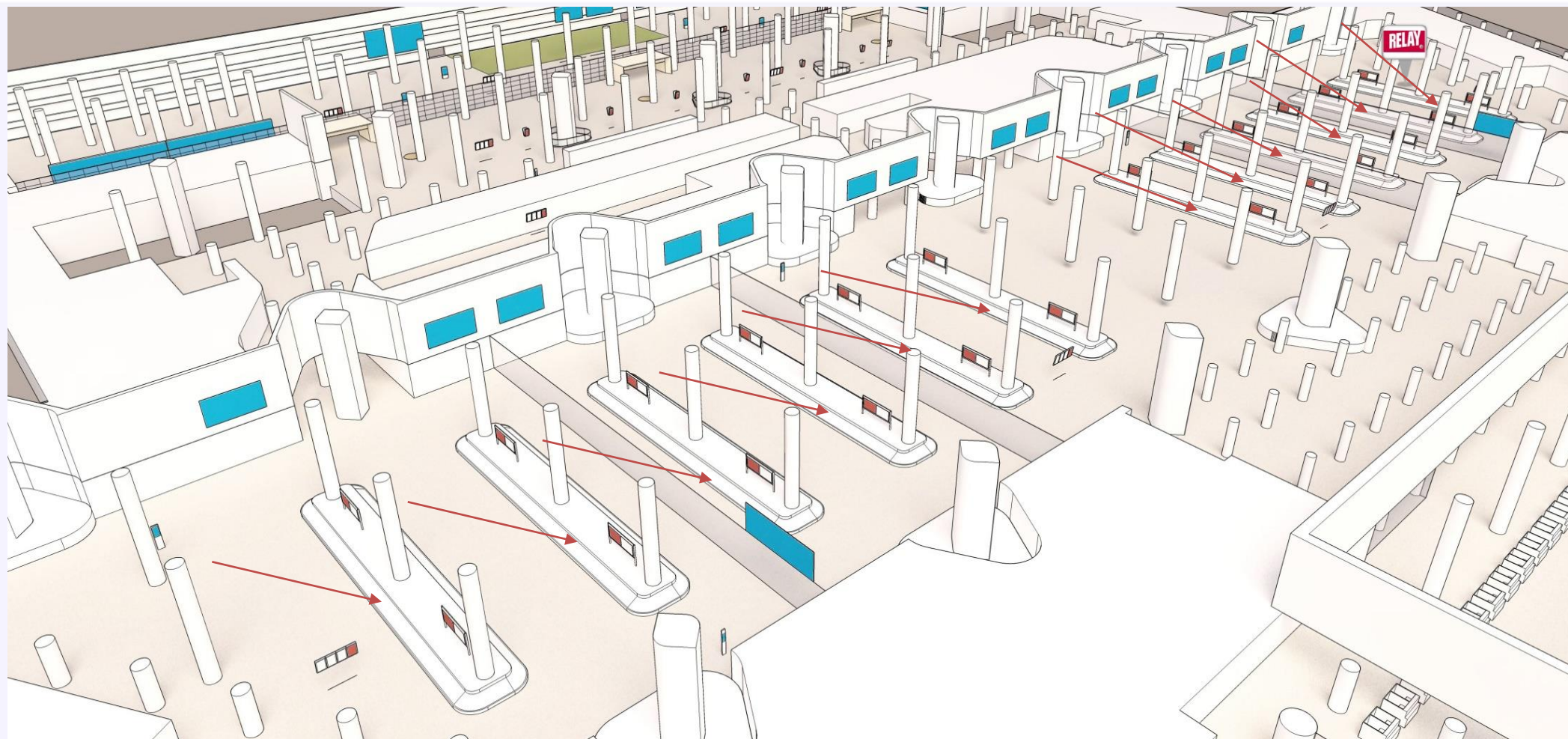

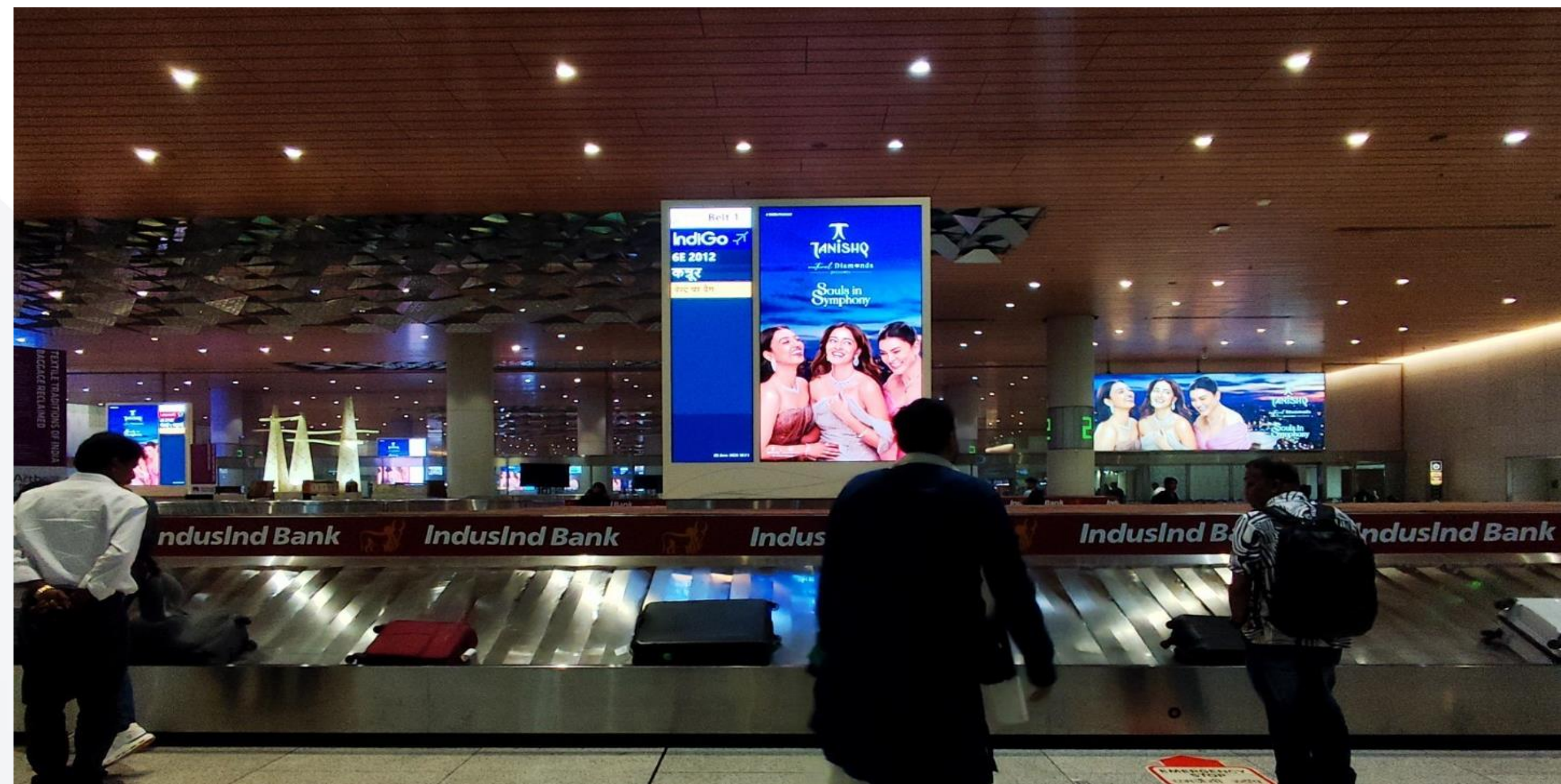

Cost Per Month 20,00,000 + GST



Video wall AFTER BAGGAGE CLAIM
Unit – 02, Size – 6 FT X 8 FT – 2 Nos., 10 sec slot in 20 sec loop

Map View

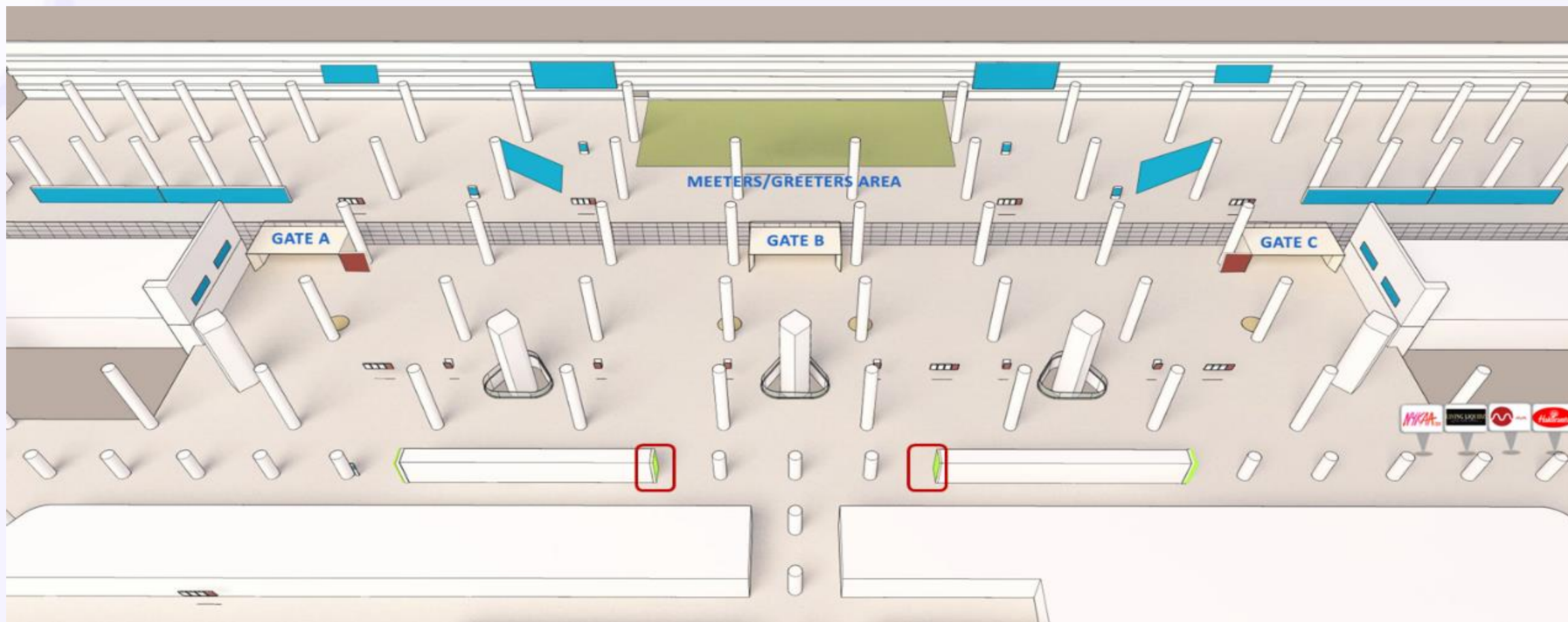



Cost Per Month 40,00,000 + GST



Arrival Videowalls Domestic Arrivals
Unit – 02, Size – 50FT X 8FT, 60 Sec/15 Sec Each

Map View

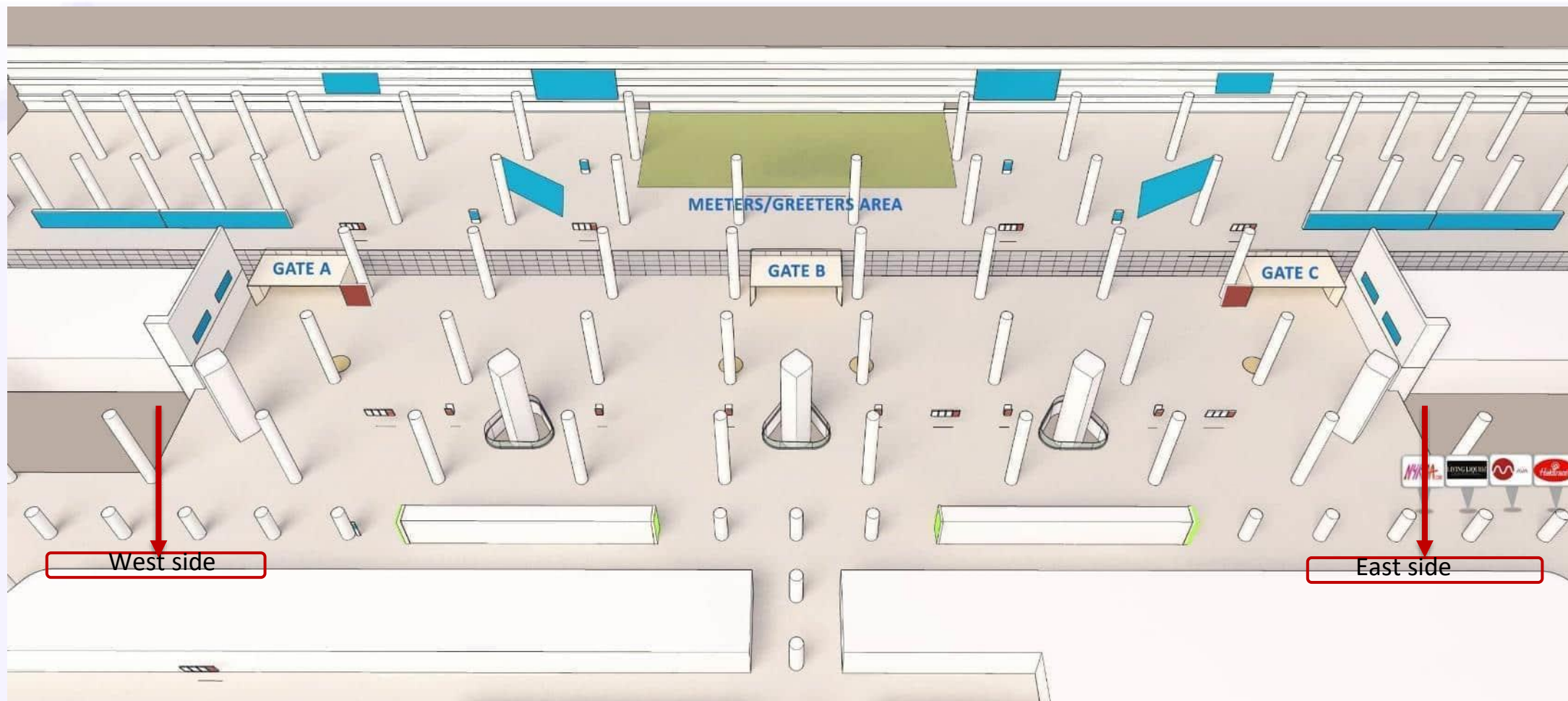





www.themediaant.com



ad@themediaant.com



080-067415510

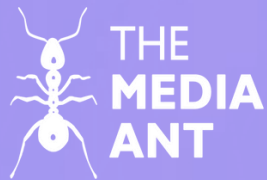

Empowering All To Advertise

Thank
You